

디지털 사이니지 솔루션

HARDWARE

General Specification

Customize available. It's on your choice!



Windows

CPU Intel Core i3/i5/i7

RAM 4/8/16 GB

Storage SSD 128/256/512 GB

OS Windows10



Android

CPU Rk3288 cortex-A17 1.8GHz

RAM 2/4/8/16 GB

Storage 4/8/16 GB

OS Android 7.1



Touch

IR Sensor

P-CAP

10Point Multi touch



HARDWARE A 결제키오스크

Payment

강원랜드납품 #프린터 #QR코드 #결제키오스크 #카드리더기



LCD

- **Model** LG LD320DUE-FHB1
- **Brightness** 400cd/m²
- **Contrast Ratio** 1100:1
- **Aspect Ratio** 16:9
- **Resolution** 1920x1080(FHD)

KIOSK

- **Dimension** 538x1773x550mm
- **Material** EGI, Safety tempered glass, Acrylic
- **Operating temperature** 0~40°C
- **Input** 100-240V(50Hz-60Hz)
- **Power consumption** 500W
- **Network** WIFI, RJ45
- **Interface** USB 2.0 x 2
- **SMPS Power** MP118FL-T 50Hz/60Hz
- **Print** HMK-072
- **QR Scanner** SYMBOL DS9208
- **Card reader** ed-977

납품사진



A02

27" KIOSK

#프린터 #QR코드 #전면카메라 #결제키오스크 #카드리더기



LCD

- **Model** LG
- **Brightness** 300cd/m²
- **Contrast Ratio** 3000:1
- **Aspect Ratio** 16:9
- **Resolution** 1920x1080(FHD)

KIOSK

- **Dimension** 1834x600x550mm
- **Material** EGI, Safety tempered glass
- **Operating temperature** 0~40°C
- **Input** 100~240V(50Hz-60Hz)
- **Power consumption** 40W
- **Network** WIFI, RJ45
- **Interface** USB 2.0
- **Print** Thermal printer 80*150mm
- **QR Scanner** 2D barcode scanner
- **Camera** 2million pixels

제품사진

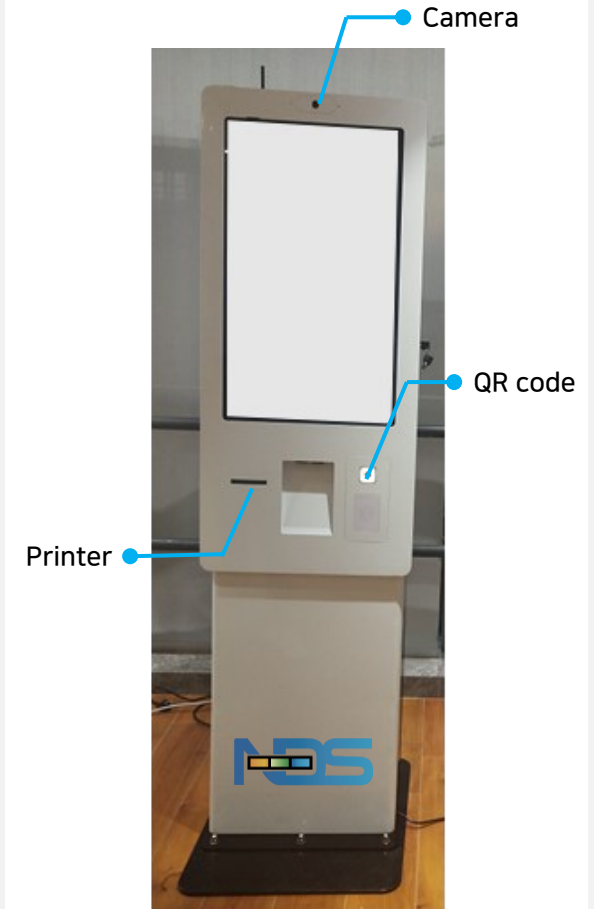

A03

21.5" KIOSK

#프린터 #QR코드 #결제키오스크 #카드리더기



LCD

- **Model** LG
- **Brightness** 300cd/m²
- **Contrast Ratio** 3000:1
- **Aspect Ratio** 16:9
- **Resolution** 1920x1080(FHD)

KIOSK

- **Dimension** 1520x310x350mm
- **Material** EGI, Safety tempered glass, Acrylic
- **Operating temperature** 0~40°C
- **Input** 100~240V(50Hz-60Hz)
- **Power consumption** 50W
- **Network** WIFI, RJ45
- **Interface** USB 2.0 x 2
- **Print** Thermal printer 80*150mm
- **QR Scanner** 2D barcode scanner
- **Card reader** Ed-977

제품사진

Card Reader

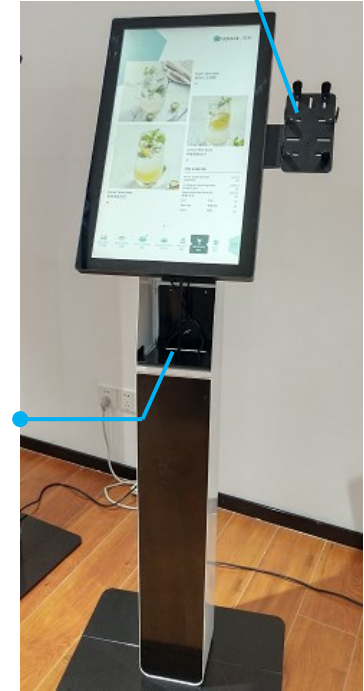

Printer

A04

21.5" KIOSK

#프린터 #QR코드 #전면카메라 #결제키오스크 #카드리더기



LCD

- **Model** LG
- **Brightness** 300cd/m²
- **Contrast Ratio** 3000:1
- **Aspect Ratio** 16:9
- **Resolution** 1920x1080(FHD)

KIOSK

- **Dimension** 910x430x250mm
- **Material** EGI, Safety tempered glass, Acrylic
- **Operating temperature** 0~40°C
- **Input** 100~240V(50Hz-60Hz)
- **Power consumption** 40W
- **Network** WIFI, RJ45
- **Interface** USB 2.0 x 2
- **Print** Thermal printer 80*150mm
- **QR Scanner** 2D barcode scanner
- **Card reader** Ed-977

제품사진

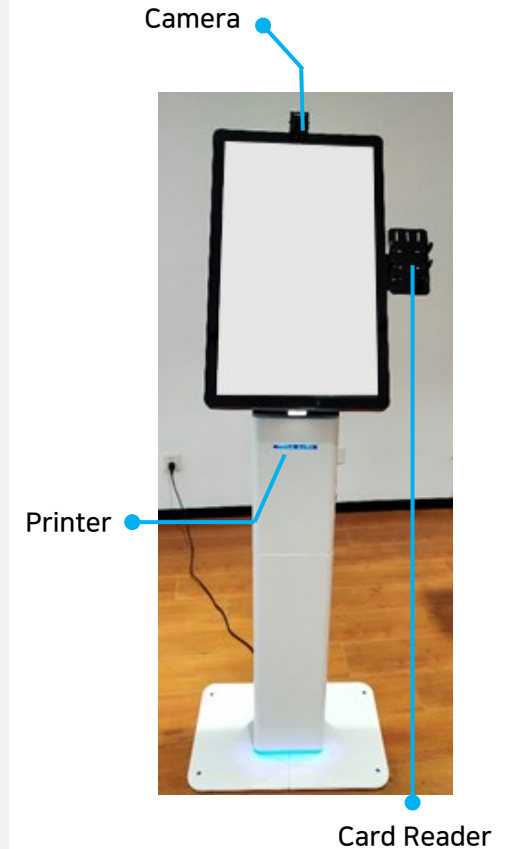

#KT/노인인력개발원납품 #프린터 #QR코드 #전면카메라 #결제키오스크

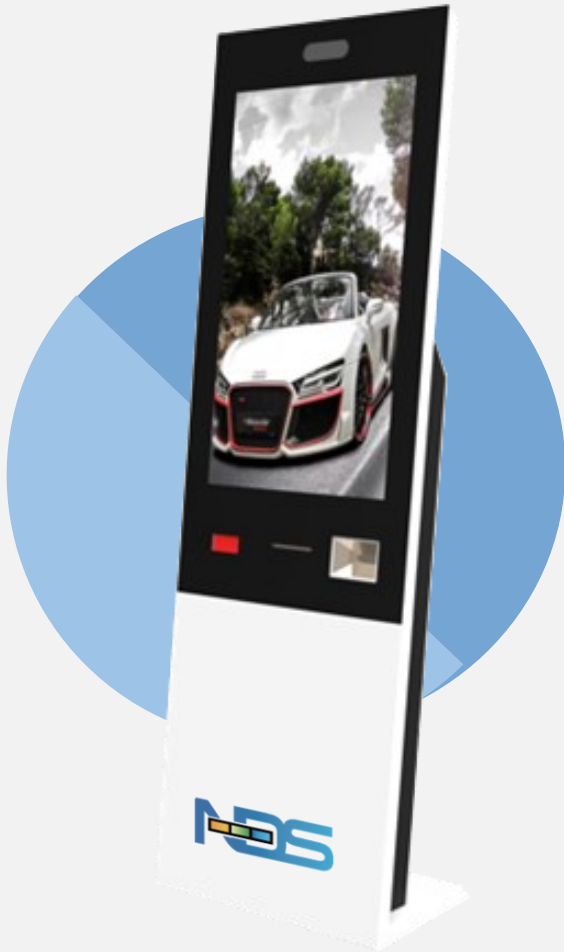

LCD

- **Model** LG
- **Brightness** 400cd/m²
- **Contrast Ratio** 1100:1
- **Aspect Ratio** 16:9
- **Resolution** 1920x1080(FHD)

KIOSK

- **Dimension** 503x1530x500mm
- **Material** EGI, Safety tempered glass, Acrylic
- **Operating temperature** 0~40°C
- **Input** 100-240V(50Hz-60Hz)
- **Power consumption** 500W
- **Network** WIFI, RJ45
- **Interface** USB 2.0 x 2
- **SMPS Power** MP118FL-T 50Hz/60Hz
- **Print** Line thermal printing 80mm
- **QR Scanner** VP8415-JX
- **Camera** 2million pixels 1080 30FPS

설치사진

Camera

Printer

QR Code
ScannerCard Reader
Holder

A06

27" KIOSK

#프린터 #QR코드 #결제키오스크

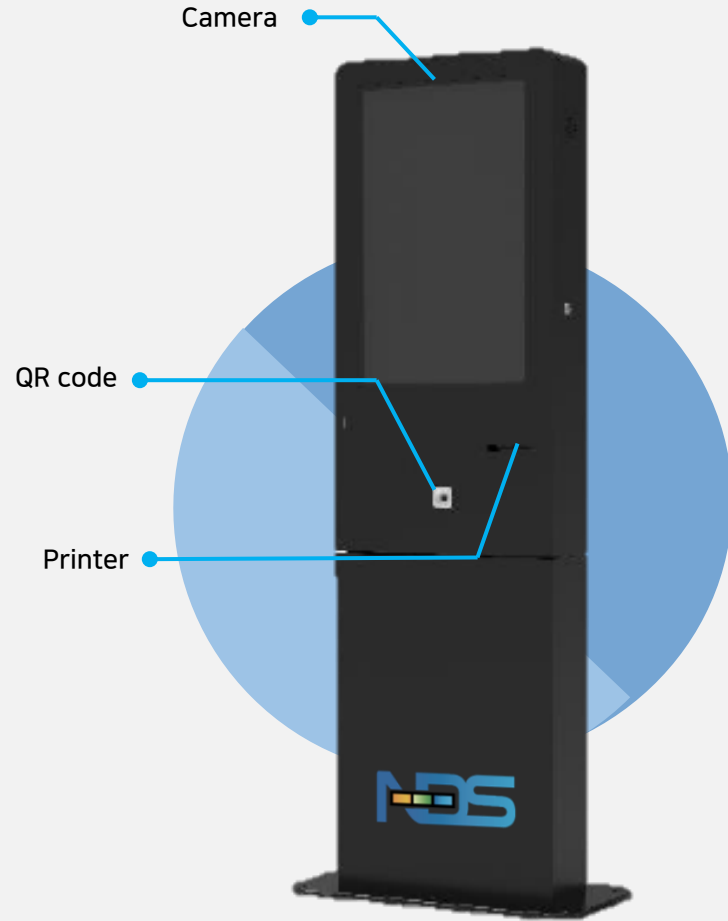

LCD

- **Model** LG
- **Brightness** 300cd/m²
- **Contrast Ratio** 3000:1
- **Aspect Ratio** 16:9
- **Resolution** 1920x1080(FHD)

KIOSK

- **Dimension** 1700x450x140mm
- **Material** EGI, Safety tempered glass
- **Operating temperature** 0~40°C
- **Input** 100-240V(50Hz-60Hz)
- **Power consumption** 40W
- **Network** WIFI, RJ45
- **Interface** USB 2.0
- **Print** Thermal printer 80*150mm
- **QR Scanner** 2D barcode scanner

#프린터 #QR코드 #결제키오스크 #얼굴인식 #바코드리더 #NFC 리더



LCD

▪ Model	21.5" LED
▪ Brightness	300cd/m ²
▪ Contrast Ratio	3000:1
▪ Aspect Ratio	16:9
▪ Resolution	1080x1920(FHD)

KIOSK

▪ Dimension	데스크 - 340(W) x 265(D) x 791(H) 스탠드 - 390(W) x 450(D) x 1595(H)
▪ Material	EGL, Safety tempered glass
▪ Operating temperature	0~40°C
▪ Input	100~240V(50Hz-60Hz)
▪ Power consumption	40W
▪ Network	WIFI, RJ45
▪ Interface	USB 2.0
▪ Card reader	IC/MSR
▪ Print	3Inch Thermal
▪ QR Scanner	2D barcode scanner
▪ Memory/SSD	DDR4 4GB / 64GB SSD
▪ CPU	Intel® Celeron Quad-Core Jasper Lake (Option : i3 / i5)
▪ Option	Camera / NFC Reader / Barcode Reader
▪ Weight	데스크 : 21kg / 스탠드 : 44kg

#프린터 #QR코드 #결제키오스크 #얼굴인식 #바코드리더 #NFC 리더



LCD

▪ Model	32" LED
▪ Brightness	300cd/m ²
▪ Contrast Ratio	3000:1
▪ Aspect Ratio	16:9
▪ Resolution	1080x1920(FHD)

KIOSK

▪ Dimension	485(W) x 420(D) x 1042(H) 베이스 미포함시 : 170(D)
▪ Material	EGI, Safety tempered glass
▪ Operating temperature	0~40°C
▪ Input	100-240V(50Hz-60Hz)
▪ Power consumption	40W
▪ Network	WIFI, RJ45
▪ Interface	USB 2.0
▪ Card reader	IC/MSR
▪ Print	3Inch Thermal
▪ QR Scanner	2D barcode scanner
▪ Memory/SSD	DDR4 4GB / 64GB SSD
▪ CPU	Intel® Celeron Quad-Core Jasper Lake (Option : i3 / i5)
▪ Option	Camera / NFC Reader / Barcode Reader
▪ Weight	41kg

HARDWARE B 세로형
Vertical



#스탠딩 #바퀴탈부착 #지면고정가능 #색상변경가능 #세로형또는피벗가능 #미러디스플레이가능



LCD

- **Model** LG
- **Active Area** 1018.08x572.67mm
- **Brightness** 450cd/m²
- **Contrast Ratio** 4000:1
- **Aspect Ratio** 16:9
- **Resolution** 1920x1080(FHD)

KIOSK

- **Dimension** 735x1900x500mm
860x1860x620mm
- **Weight** 100kg
- **Material** EGI, Safety tempered glass
- **Operating temperature** 0~50°C
- **Input** 100-240V(50Hz-60Hz)
- **Power consumption** 350W
- **Network** WIFI, RJ45

설치사진



#스탠딩 #바퀴탈부착 #지면고정가능 #색상변경가능 #하단로고부착가능 #양면디스플레이가능



LCD

- **Model** LG
- **Brightness** 450cd/m²
- **Contrast Ratio** 4000:1
- **Aspect Ratio** 16:9
- **Resolution** 1920x1080(FHD)

KIOSK

- **Dimension** 700x1900x590mm
980x2127.5x650mm
- **Weight** 100kg / 180kg
- **Material** EGI, Safety tempered glass
- **Operating temperature** 0~50°C
- **Input** 100-240V(50Hz-60Hz)
- **Power consumption** 500W
- **Network** WIFI, RJ45

설치사진

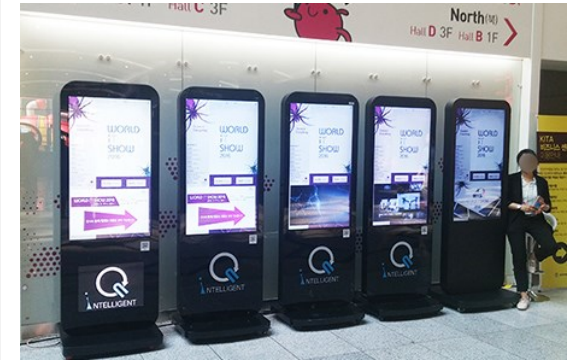

#스탠딩 #바퀴탈부착 #지면고정가능 #색상변경가능 #아이들도사용가능한높이 #하단로고삽입가능

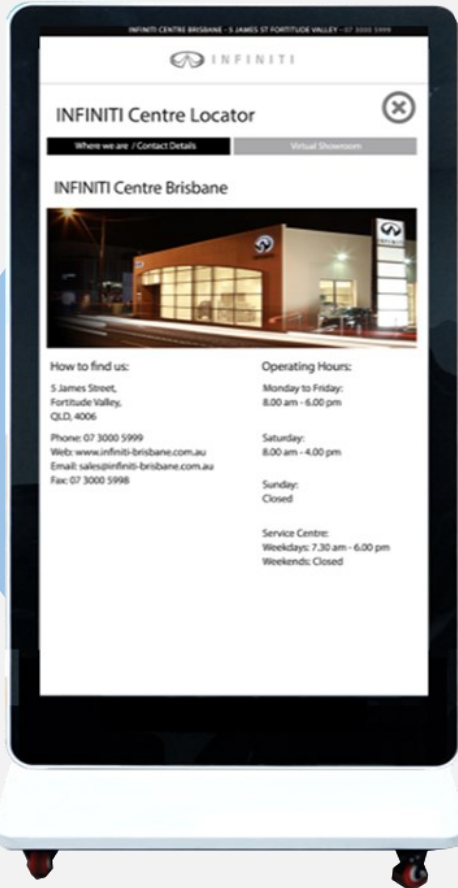

LCD

- **Model** LG
- **Brightness** 450cd/m²
- **Contrast Ratio** 1400:1
- **Aspect Ratio** 16:9
- **Resolution** 1920x1080(FHD)

KIOSK

- **Dimension** 925x1700x550(110)mm
- **Weight** 100kg
- **Material** EGI, Safety tempered glass, Acrylic
- **Operating temperature** 0~40°C
- **Input** 100~240V(50Hz-60Hz)
- **Power consumption** 500W
- **Network** WIFI, RJ45

설치사진



#스탠딩 #바퀴탈부착 #지면고정가능 #색상변경가능 #아이들도사용가능한높이



LCD

▪ Model	LG
▪ Brightness	450cd/m ²
▪ Contrast Ratio	1400:1
▪ Aspect Ratio	16:9
▪ Resolution	1920x1080(FHD)

KIOSK

▪ Dimension	925x1700x550(110)mm
▪ Weight	100kg
▪ Material	EGI, Safety tempered glass
▪ Operating temperature	0~50℃
▪ Input	100~240V(50Hz-60Hz)
▪ Power consumption	500W
▪ Network	WIFI, RJ45

#스탠딩 #바퀴탈부착 #지면고정가능 #색상변경가능 #하단로고부착가능 #서울시평생교육원납품



LCD

- **Model** LG
- **Brightness** 450cd/m²
- **Contrast Ratio** 1300:1
- **Aspect Ratio** 16:9
- **Resolution** 1920x1080(FHD)

KIOSK

- **Dimension** 640x66x1760mm
837x2127.5x650mm ± 200mm
- **Weight** 50kg
- **Material** EGI, Safety tempered glass
- **Operating temperature** 0~50°C
- **Input** 100~240V(50Hz-60Hz)
- **Power consumption** 350W
- **Network** WIFI, RJ45

설치사진

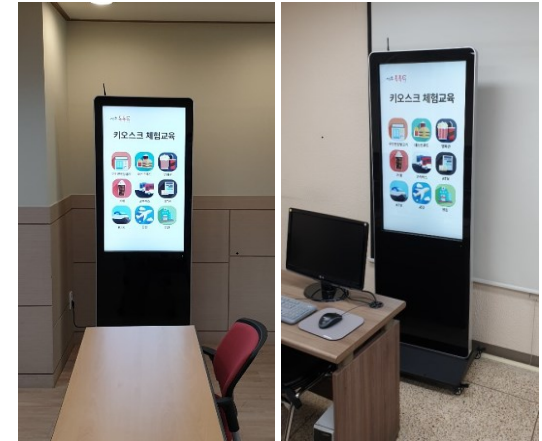
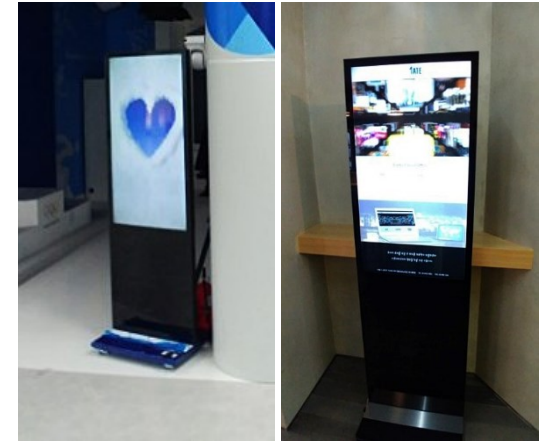

#스탠딩 #바퀴탈부착 #지면고정가능 #색상변경가능 #전면카메라 #스티커부착가능



LCD

- **Model** LG LD490EUE-FHB1
- **Brightness** 450cd/m²
- **Contrast Ratio** 1400:1
- **Aspect Ratio** 16:9
- **Resolution** 1920x1080(FHD)

KIOSK

- **Dimension** 735x1900x500mm
- **Material** EGI, Safety tempered glass
- **Operating temperature** 0~50°C
- **Input** 100-240V(50Hz-60Hz)
- **Power consumption** 350W
- **Network** WIFI, RJ45
- **Interface** USB 2.0 x 2 , HDMI 2.0 x 1
- **Speaker** 8Ω10W-P
- **Camera** 1920*1080P

설치사진



#스탠딩 #바퀴탈부착 #지면고정가능 #색상변경가능 #하단로고부착가능



LCD

▪ Model	LG
▪ Brightness	350cd/m ²
▪ Contrast Ratio	1300:1
▪ Aspect Ratio	16:9
▪ Resolution	1920x1080(FHD)

KIOSK

▪ Dimension	770x1835x643mm
▪ Weight	50kg
▪ Material	EGI, Safety tempered glass
▪ Operating temperature	0~50℃
▪ Input	100-240V(50Hz-60Hz)
▪ Power consumption	350W
▪ Network	WIFI, RJ45

#스탠딩 #바퀴탈부착 #지면고정가능 #색상변경가능 #하단로그부착가능 #미러디스플레이가능

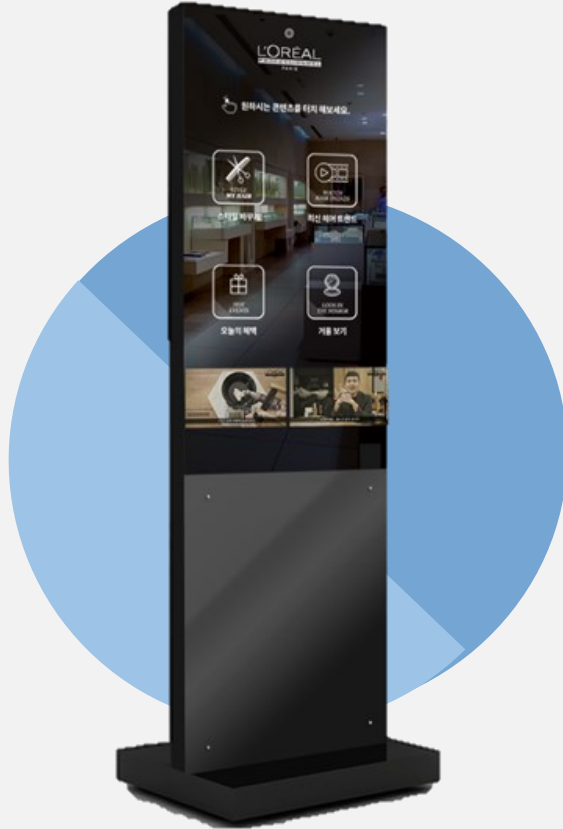

LCD

- **Model** LG
- **Brightness** 450cd/m²
- **Size** 31.5"
- **Aspect Ratio** 16:9
- **Resolution** 1920x1080(FHD)

KIOSK

- **Dimension** 727.4x429x227mm
- **Weight** 60kg
- **Material** Metal, Safety tempered glass
- **Operating temperature** 0~35℃
- **Input** 100-240V(50Hz-60Hz)
- **Power consumption** 25W
- **Network** WIFI, RJ45

#스탠딩 #바퀴탈부착 #지면고정가능 #색상변경가능 #하단로고부착가능 #바코드리더기연동 #POS연동 #프린터연동



LCD

- | | |
|-------------------------|----------------------|
| ▪ Model | LG |
| ▪ Brightness | 350cd/m ² |
| ▪ Contrast Ratio | 1300:1 |
| ▪ Aspect Ratio | 16:9 |
| ▪ Resolution | 1920x1080(FHD) |

KIOSK

- | | |
|--------------------------------|----------------------------|
| ▪ Dimension | 740x1550x450mm |
| ▪ Weight | 50kg |
| ▪ Material | EGI, Safety tempered glass |
| ▪ Operating temperature | 0~50°C |
| ▪ Input | 100-240V(50Hz-60Hz) |
| ▪ Power consumption | 350W |
| ▪ Network | WIFI, RJ45 |

설치사진



#스탠딩 #바퀴탈부착 #지면고정가능 #색상변경가능 #하단로그부착가능 #듀얼스크린 #옥외용가능

INDOOR

OUTDOOR



LCD(Indoor)

- **Model** LG 32+21.5inch
- **Brightness** 450cd/m²
- **Contrast Ratio** 4000:1
- **Aspect Ratio** 16:9
- **Resolution** 1920x1080(FHD)

LCD(Outdoor)

- **Model** LG 32+21.5inch
- **Grass** 6mm AR tempered
- **Brightness** 1500cd/m²
- **Contrast Ratio** 4000:1
- **Aspect Ratio** 16:9
- **Resolution** 1920x1080(FHD)

KIOSK

- **Dimension** 620x2100x446mm
580x2100x442mm
- **Weight** 120kg
- **Material** EGI, Safety tempered glass
- **Operating temperature** 0~50°C(Indoor) / -20~60 °C(Outdoor)
- **Input** 100~240V(50Hz-60Hz)
- **Power consumption** 400W
- **Network** WIFI, RJ45

설치사진



#스탠딩 #바퀴탈부착 #지면고정가능 #색상변경가능 #하단로고부착가능 #듀얼모니터

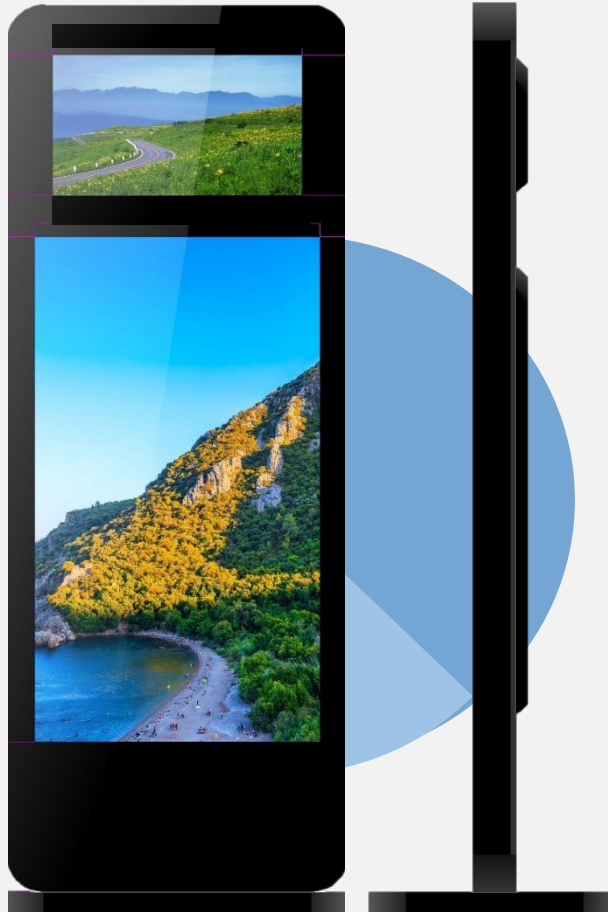

LCD(55")

- **Model** LG
- **Brightness** 450cd/m²
- **Contrast Ratio** 1300:1
- **Aspect Ratio** 16:9
- **Resolution** 1920x1080(FHD)W
- **Power consumption** 350W

LCD(27")

- **Model** LG
- **Brightness** 300cd/m²
- **Contrast Ratio** 1300:1
- **Aspect Ratio** 16:9
- **Resolution** 1920x1080(FHD)
- **Power consumption** 650W

#스탠딩 #바퀴탈부착 #지면고정가능 #색상변경가능 #하단로고부착가능 #듀얼모니터 #얼굴인식 #음성인식 #동작센서 #3D LED

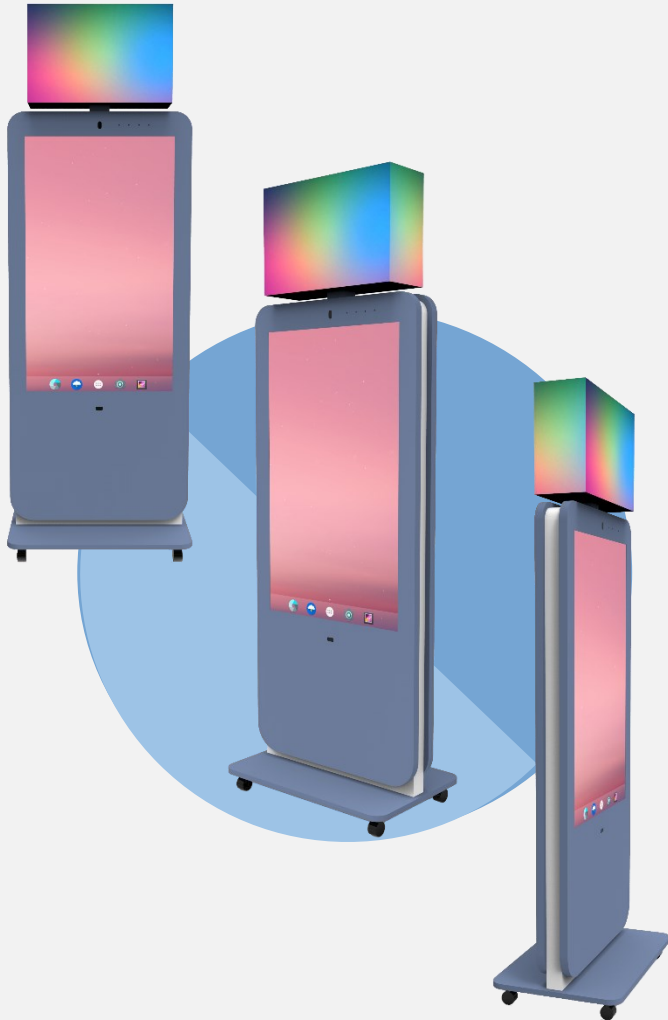

LED

- Dinemson 576x384x192mm
- Pitch P3.0
- Module size 192*192mm
- Resolution 64*64

LCD

- **Model** 49inch
- Glass AR tempered
- Brightness 500cd/m²
- Contrast Ratio 4000:1
- Aspect Ratio 16:9
- Resolution 1920x1080(FHD)

KIOSK

- Dinemson 950x2390x384mm
- Weight 120kg
- Material Galvanized steel painting
- Storage temperature -20°C~50°C
- Input 100-240V(50Hz-60Hz)
- Power consumption 500W
- Network WIFI, RJ45
- Other Camera, 동작센서, 스피커, 마이크

PLAYER

- Android
- CPU: RK 2388
- RAM: 4G
- Storage: 16G
- Windows
- CPU: I5
- RAM: 8G
- Storage: 128G

Picture

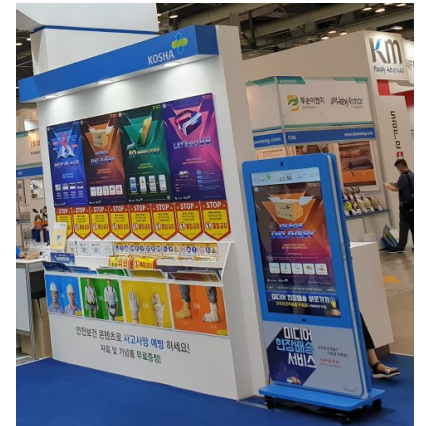

#스탠딩 #바퀴탈부착 #지면고정가능 #색상변경가능 #하단로고부착가능 #부천중동힐스테이트

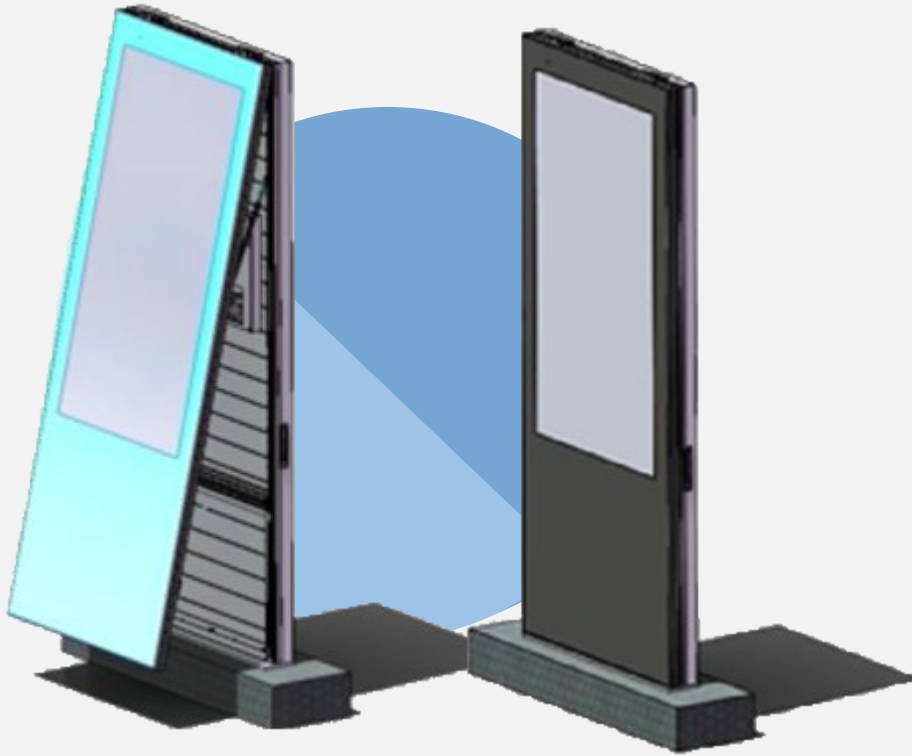

LCD

▪ Model	LG
▪ Brightness	450cd/m ²
▪ Size	31.5"
▪ Aspect Ratio	16:9
▪ Resolution	1920x1080(FHD)

KIOSK

▪ Dimension	760x125x227mm
▪ Weight	60kg
▪ Material	Metal, Safety tempered glass
▪ Operating temperature	0~35°C
▪ Input	100-240V(50Hz-60Hz)
▪ Power consumption	25W
▪ Network	WIFI, RJ45

#스탠딩 #바퀴탈부착 #지면고정가능 #색상변경가능 #하단로고부착가능 #얼굴인식



LCD

- **Model** 43inch
- Glass AR tempered
- Brightness 500cd/m²
- Contrast Ratio 4000:1
- Aspect Ratio 16:9
- Resolution 1920x1080(FHD)

KIOSK

- Dimension 950x2390x384mm
- Weight 90kg
- Material Galvanized steel painting
- Storage temperature -20°C~50°C
- Input 100-240V(50Hz-60Hz)
- Power consumption 500W
- Network WIFI, RJ45
- Other Camera, 동작센서, 스피커, 마이크

PLAYER

- OS WIN10
- CPU I5
- RAM 8G
- SSD 256G
- GPU GeForce GTX1660(6G GDDR5)

OTHER

- 얼굴인식 카메라

Picture

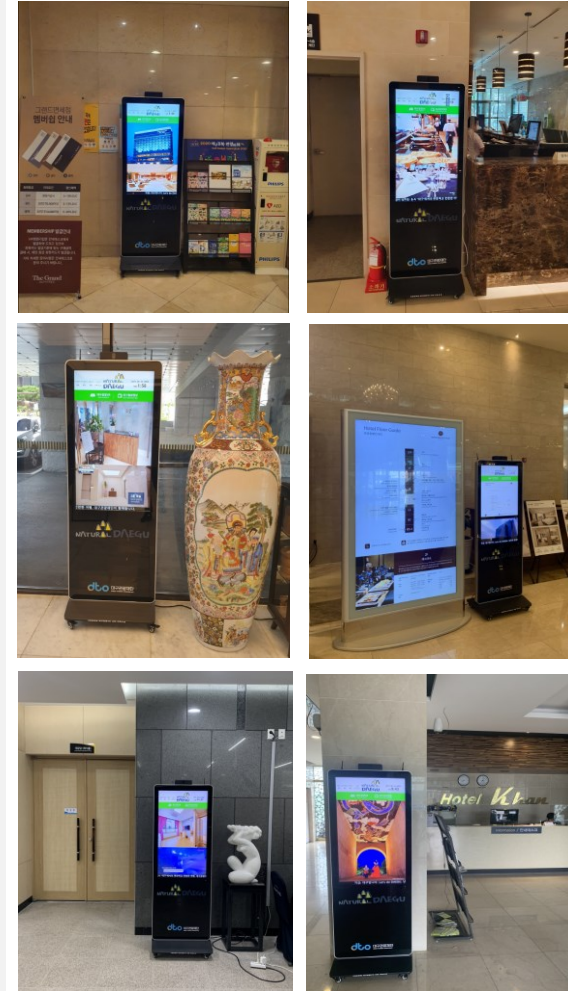



HARDWARE C 가로형

Horizontal

#가로형 #바퀴탈부착 #지면고정가능 #색상변경가능 #하단로그부착가능 #워커히호텔납품 #국립태안해양박물관납품 #울산정보화진흥원납품



LCD

- **Model** LG
- **Brightness** 450cd/m²
- **Contrast Ratio** 1400:1
- **Aspect Ratio** 16:9
- **Resolution** 1920x1080(FHD)

KIOSK

- **Dimension** 750x1027x1370.75mm ± 200mm
- **Weight** 90kg
- **Material** EGI, Safety tempered glass
- **Operating temperature** 0~50°C
- **Input** 100~240V(50Hz-60Hz)
- **Power consumption** 350W
- **Network** WIFI, RJ45

설치사진



#가로형 #바퀴탈부착 #지면고정가능 #색상변경가능 #하단로그부착가능



LCD

▪ Model	LG
▪ Brightness	450cd/m ²
▪ Contrast Ratio	4000:1
▪ Aspect Ratio	16:9
▪ Resolution	1920x1080(FHD)

KIOSK

▪ Dimension	1370x1500x650mm ± 300mm
▪ Weight	120kg
▪ Material	EGL, Safety tempered glass
▪ Operating temperature	0~50℃
▪ Input	100-240V(50Hz-60Hz)
▪ Power consumption	350W
▪ Network	WIFI, RJ45

#가로형 #바퀴탈부착 #지면고정가능 #색상변경가능 #하단로그부착가능



LCD

- **Model** LG
- **Brightness** 450cd/m²
- **Contrast Ratio** 4000:1
- **Aspect Ratio** 16:9
- **Resolution** 1920x1080(FHD)

KIOSK

- **Dimension** 750x1027x1370.75mm ± 200mm
- **Weight** 120kg
- **Material** EGI, Safety tempered glass
- **Operating temperature** 0~50℃
- **Input** 100-240V(50Hz-60Hz)
- **Power consumption** 500W
- **Network** WIFI, RJ45

#가로형 #바퀴탈부착 #지면고정가능 #색상변경가능 #하단로고부착가능



LCD

- **Model** LG
- **Brightness** 450cd/m²
- **Contrast Ratio** 1400:1
- **Aspect Ratio** 16:9
- **Resolution** 1920x1080(FHD)

KIOSK

- **Dimension** 750x1027x1370.75mm ± 200mm
- **Weight** 90kg
- **Material** EGI, Safety tempered glass
- **Operating temperature** 0~50℃
- **Input** 100-240V(50Hz-60Hz)
- **Power consumption** 350W
- **Network** WIFI, RJ45

HARDWARE D 회전형
Pivot

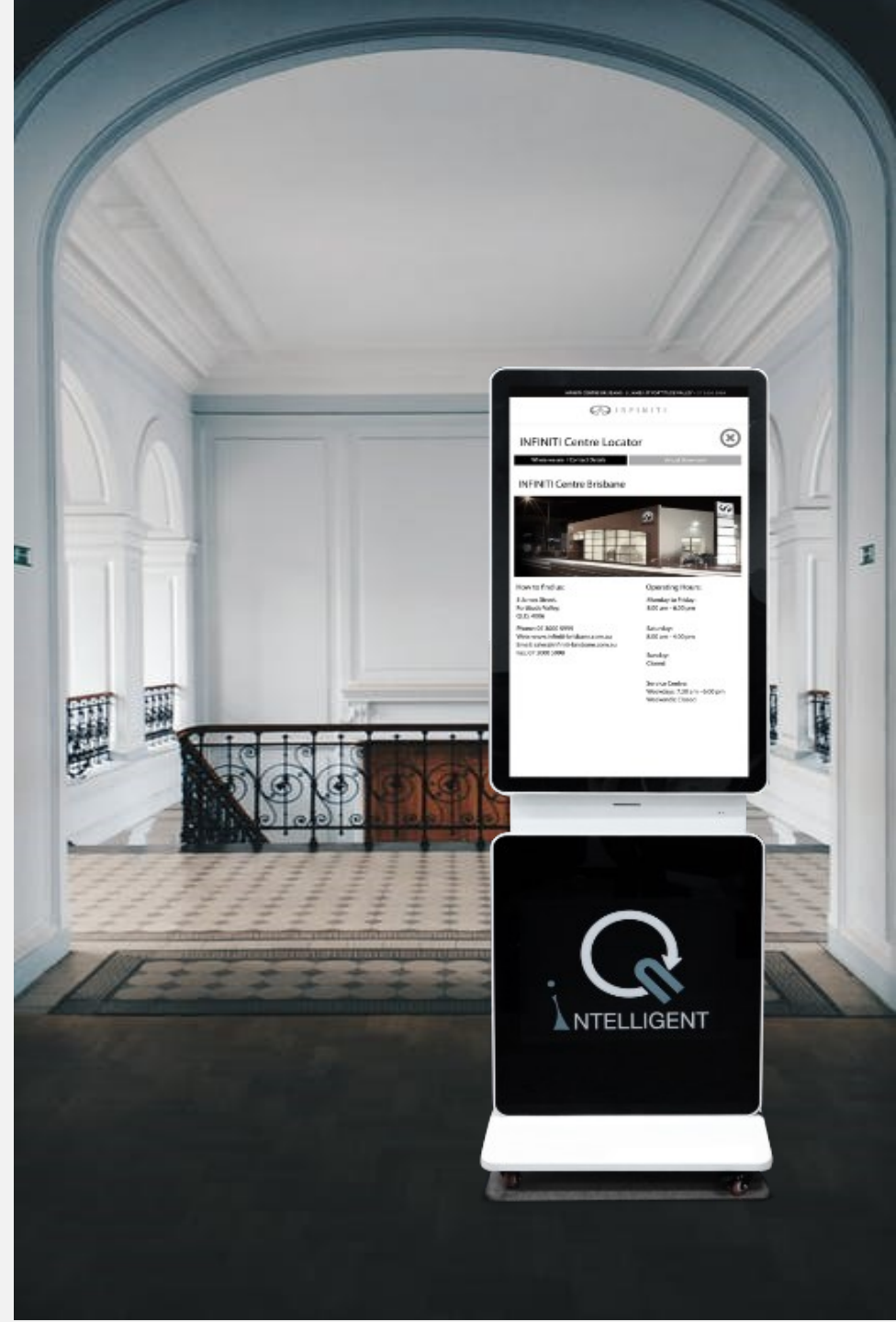

#회전형 #바퀴탈부착 #지면고정가능 #색상변경가능 #하단로고부착가능 #WindowOS자동회전 #예비군훈련소납품

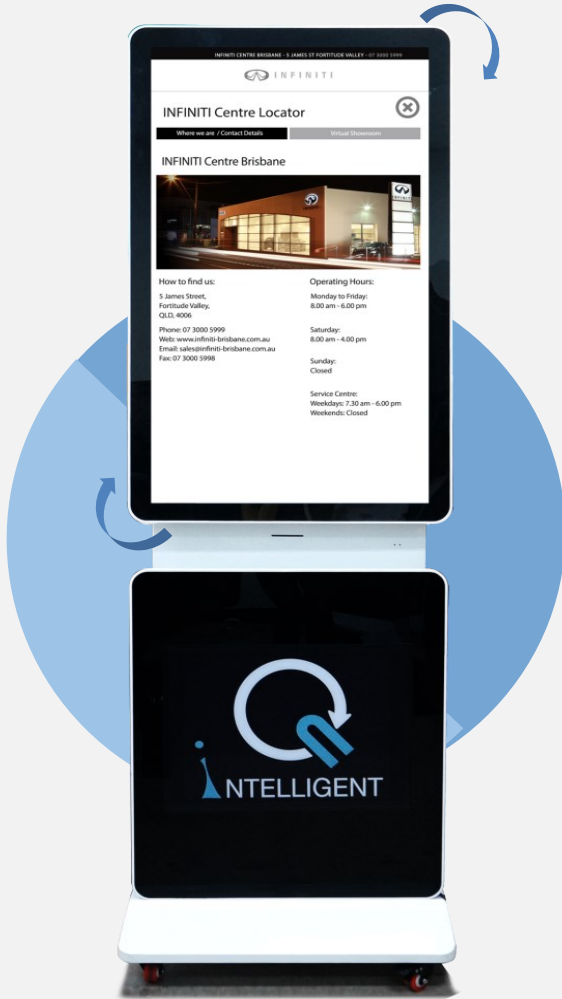

LCD

- **Model** LG
- **Brightness** 450cd/m²
- **Contrast Ratio** 1100:1
- **Aspect Ratio** 16:9
- **Resolution** 1920x1080(FHD)

KIOSK

- **Dimension** 718x475x1625mm
- **Material** EGI, Safety tempered glass
- **Operating temperature** 0~50°C
- **Input** 100-240V(50Hz-60Hz)
- **Power consumption** 350W
- **Network** WIFI, RJ45
- **Interface** USB 2.0 x 2
- **Speaker** 5~10W * 2

피벗예시



#회전형 #바퀴탈부착 #지면고정가능 #색상변경가능 #하단로그부착가능 #WindowOS자동회전 #아이들도사용가능한높이

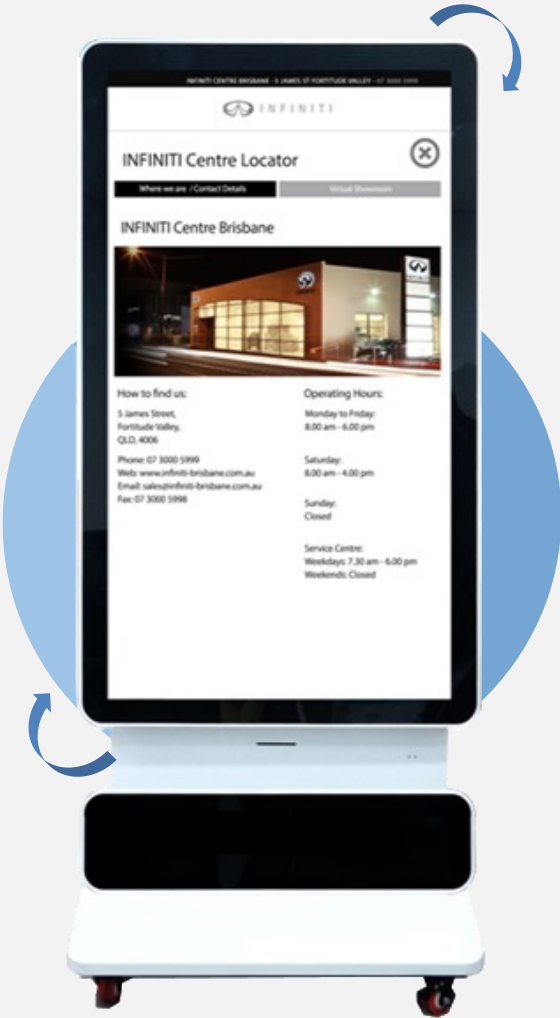

LCD

- **Model** LG
- **Brightness** 450cd/m²
- **Contrast Ratio** 1400:1
- **Aspect Ratio** 16:9
- **Resolution** 1920x1080(FHD)

KIOSK

- **Dimension** 785.82x1700x450(120)mm
- **Material** EGI, Safety tempered glass
- **Operating temperature** 0~50°C
- **Input** 100~240V(50Hz~60Hz)
- **Power consumption** 500W
- **Network** WIFI, RJ45

설치사진

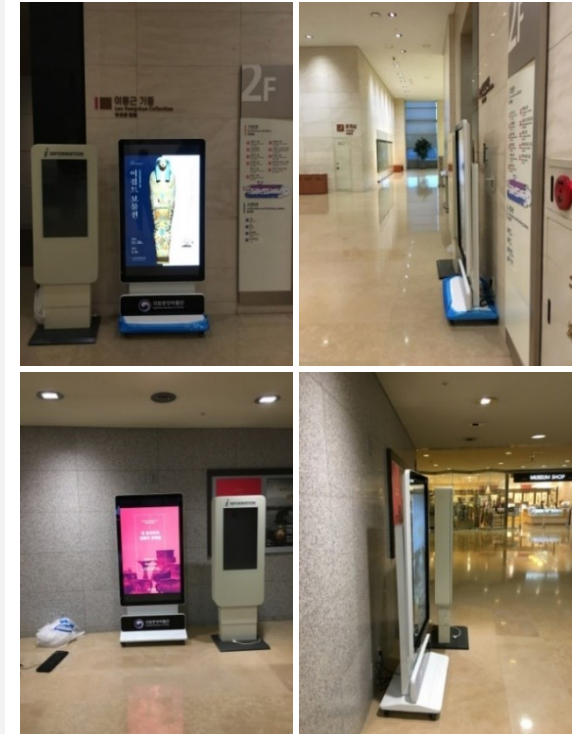



HARDWARE E 옥외용
Outdoor

#옥외용 #지면고정 #하단/측면로고삽입가능 #색상변경가능 #IP55방수 #주변기기장착가능 #판교테크노밸리납품 #하이원리조트납품



LCD

- **Model** LG(Outdoor)
- **Glass** AR tempered
- **Brightness** 2000cd/m²
- **Contrast Ratio** 4000:1
- **Aspect Ratio** 16:9
- **Resolution** 1920x1080(FHD)

KIOSK

- **Dinemsion** 880x21874x400mm
- **Weight** 220kg
- **Material** Galvanized steel painting
- **Storage temperature** -20℃~50℃
- **Input** 100-240V(50Hz-60Hz)
- **Power consumption** 400W
- **Network** WIFI, RJ45

설치사진



#옥외용 #지면고정 #하단/측면로고삽입가능 #색상변경가능 #IP55방수 #주변기기장착가능



LCD

- **Model** LG(Outdoor)
- **Glass** 6mm AR tempered
- **Brightness** 2000cd/m²
- **Contrast Ratio** 4000:1
- **Aspect Ratio** 16:9
- **Resolution** 1920x1080(FHD)

KIOSK

- **Dinemsion** 820x1450x220mm
- **Weight** 220kg
- **Material** Galvanized steel painting
- **Storage temperature** -20℃~60℃
- **Input** 100~240V(50Hz~60Hz)
- **Power consumption** 400W
- **Network** WIFI, RJ45

설치사진



#옥외용 #지면고정 #하단/측면로고삽입가능 #색상변경가능 #IP55방수 #주변기기장착가능 #하이원리조트납품



LCD

- **Model** LG(Outdoor)
- **Glass** 6mm AR tempered
- **Brightness** 2500cd/m²
- **Contrast Ratio** 4000:1
- **Aspect Ratio** 16:9
- **Resolution** 1920x1080(FHD)

KIOSK

- **Dinemsion** 880x2000x230mm
- **Weight** 220kg
- **Material** Galvanized steel painting
- **Storage temperature** -20℃~60℃
- **Input** 100~240V(50Hz~60Hz)
- **Power consumption** 400W
- **Network** WIFI, RJ45

설치사진



#옥외용 #지면고정 #색상변경가능 #방수 #스탠드형 #벽걸이형



LCD

- **Model** LG 32" TFT-LCD
- **Brightness** 1500cd/m²
- **Contrast Ratio** 2000:1
- **Aspect Ratio** 16:9
- **Resolution** 1920x1080(FHD)

KIOSK

- **Dimension(Stand)** 900x310x1615mm
- **Dimension(Hanging)** 900x150x515mm
- **Material** EGI, Safety tempered glass
- **Operating temperature** 0~50℃
- **Storage temperature** -35℃~55℃
- **Input** 100~240V(50Hz~60Hz)
- **Power consumption** 350W
- **Network** WIFI, RJ45
- **Interface** USB 2.0 x 2 , HDMI 2.0 x 1
- **Speaker** 2x10W (8 ohm)

설치사진



#옥외용 #지면고정 #하단/측면로고삽입가능 #색상변경가능 #IP55방수 #주변기기장착가능



LCD

- **Model** LG(Outdoor)
- **Glass** 6mm AR tempered
- **Brightness** 2500cd/m²
- **Contrast Ratio** 4000:1
- **Aspect Ratio** 16:9
- **Resolution** 1920x1080(FHD)

KIOSK

- **Dinemsion** 1600x2300x650mm
- **Weight** 220kg
- **Material** SUS304
- **Storage temperature** -20℃~55℃
- **Input** 100~240V(50Hz~60Hz)
- **Power consumption** 600W
- **Network** WIFI, RJ45

설치사진



#옥외용 #지면고정 #하단/측면로고삽입가능 #색상변경가능 #3DLED #모션센서



LED

- Dinension 576x384x384mm
- Pitch P3.0
- Module size 192*192mm
- Resolution 64*64
- level IP65 , IP54

LCD

- Model 55inch
- Glass AR tempered
- Brightness 3000cd/m²
- Contrast Ratio 4000:1
- Aspect Ratio 16:9
- Resolution 1920x1080(FHD)

KIOSK

- Dinension 950x2390x384mm
- Weight 270kg
- Material Galvanized steel painting
- Storage temperature -20°C~50°C
- Input 100-240V(50Hz-60Hz)
- Power consumption 1500W,2000W
- Network WIFI, RJ45
- Air conditioning system Cooling fan

PLAYER

- Android
- CPU: RK 2388
- RAM: 4G
- Storage: 16G
- Windows
- CPU: I7
- RAM: 8G
- Storage: 128G

Picture

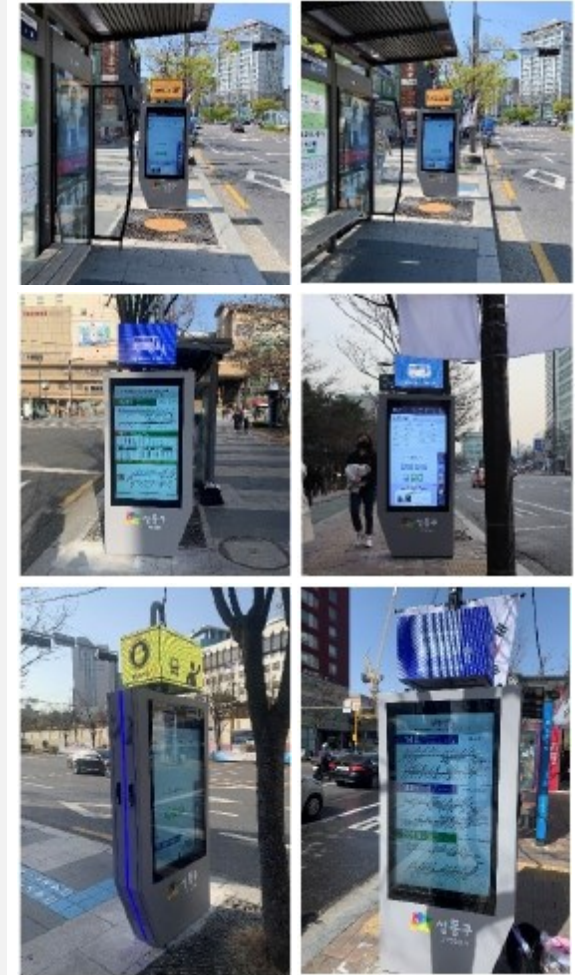

#옥외용 #지면고정 #하단/측면로고삽입가능 #색상변경가능 #IP55방수 #주변기기장착가능 #CCTV #음성출력



LCD

- **Model** 40inch/55inch
- **Glass** 6mm AR tempered
- **Brightness** 1500cd/m²
- **Contrast Ratio** 4000:1
- **Aspect Ratio** 16:9
- **Resolution** 1920x1080(FHD)

KIOSK

- **Dinemsion** 2000x4400x800mm/
2000x3500x800mm
- **Weight** 220kg
- **Material** Galvanized steel painting
- **Storage temperature** -20℃~60℃
- **Input** 100-240V(50Hz-60Hz)
- **Power consumption** 1500W
- **Network** WIFI, RJ45

설치사진



HARDWARE F 테이블형
Table



#테이블형 #바퀴탈부착 #지면고정가능 #하단로고삽입가능 #색상변경가능



LCD

- **Model** LG
- **Brightness** 450cd/m²
- **Contrast Ratio** 1300:1
- **Aspect Ratio** 16:9
- **Resolution** 1920x1080(FHD)

KIOSK

- **Dimension** 1760x860x750mm
- **Weight** 110kg
- **Material** EGI, Safety tempered glass
- **Storage temperature** 0~50°C
- **Input** 100~240V(50Hz-60Hz)
- **Power consumption** 500W
- **Network** WIFI, RJ45

설치사진

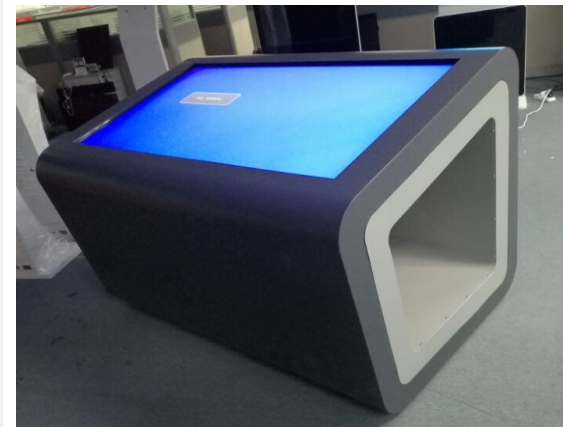

#테이블형 #바퀴탈부착 #지면고정가능 #하단로고삽입가능 #색상변경가능 #미팅룸 #데모룸



LCD

- **Model** LG
- **Brightness** 450cd/m²
- **Contrast Ratio** 1300:1
- **Aspect Ratio** 16:9
- **Resolution** 1920x1080(FHD)

KIOSK

- **Dimension** 1760x860x750mm
- **Weight** 120kg
- **Material** EGI, Safety tempered glass
- **Storage temperature** 0~50°C
- **Input** 100~240V(50Hz-60Hz)
- **Power consumption** 500W
- **Network** WIFI, RJ45

설치사진

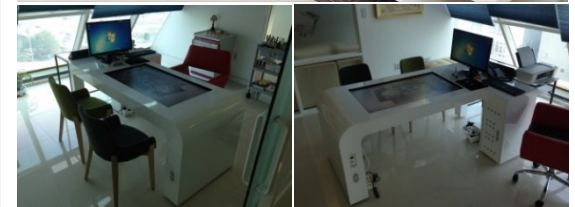

#테이블형 #바퀴탈부착 #지면고정가능 #하단로고삽입가능 #색상변경가능 #미팅룸 #데모룸



LCD

- **Model** LG
- **Brightness** 450cd/m²
- **Contrast Ratio** 1300:1
- **Aspect Ratio** 16:9
- **Resolution** 1920x1080(FHD)

KIOSK

- **Dimension** 1004.5x466.88x755.5mm
- **Weight** 70kg
- **Material** EGI, Safety tempered glass
- **Storage temperature** 0~50°C
- **Input** 100~240V(50Hz-60Hz)
- **Power consumption** 500W
- **Network** WIFI, RJ45

설치사진



HARDWARE G 기타
Others



#모니터형 #벽걸이 #벽내장 #색상변경가능 #사이즈변경가능



LCD

- Model 24inch Panel
- Resolution 1920*1080
- Brightness 250cd/m²
- Contrast Ratio 700 : 1
- Aspect Ratio 16:9
- Network 802.11b/g/n
100M/1000M Ethernet
Bluetooth 4.0
- Interface USB RJ45 HDMI
3.5mm earphone
- Power consumption 35W
- Speaker 2*3W
- Camera 2.0M/P, front camera
- Dimension 580*349*32.5mm(L*W*H)
- Adapter Adapter, 12V/3A

설치사진

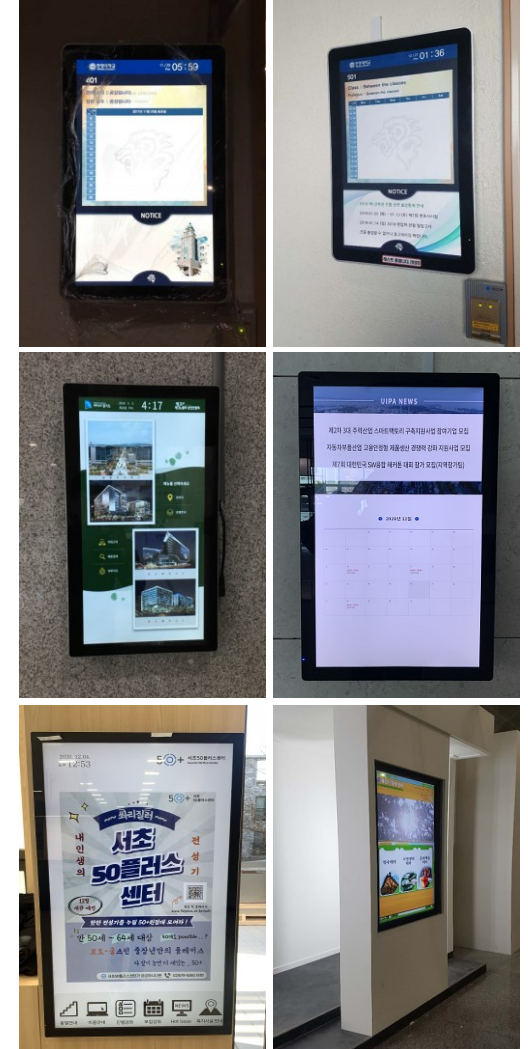

#모니터형 #벽걸이 #벽내장 #색상변경가능 #사이즈변경가능

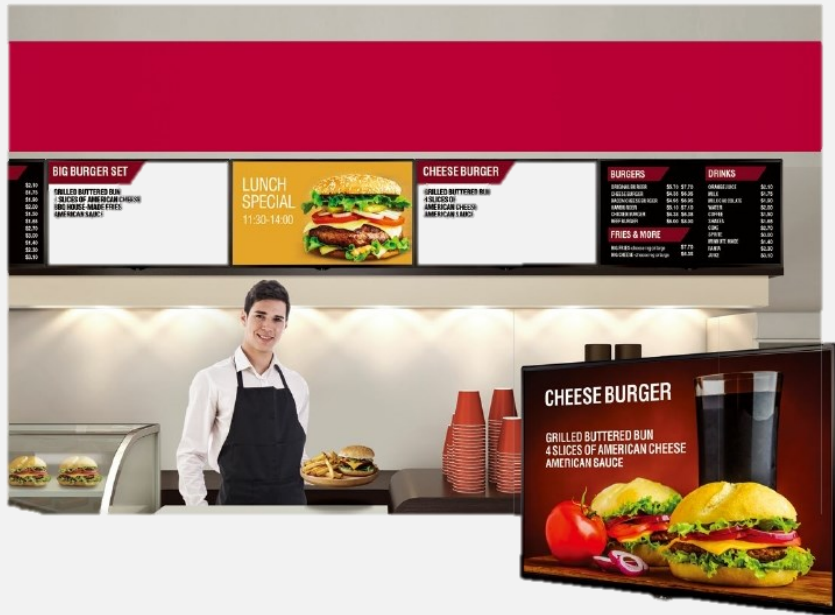

		65SM5D	55SM5D	49SM5D	43SM5D
PANEL	Screen Size	65"	55"	49"	43"
	Panel Technology	IPS			
	Aspect Ratio	16 : 9			
	Native Resolution	1,920 x 1,080 (FHD)			
	Brightness	450 cd/m ²			
	Viewing Angle (H x V)	178 x 178			
CONNECTIVITY	Response Time	10 ms (G to G), 8 ms (MPRT)	12 ms (G to G BW), 9 ms (WOT)	12 ms (G to G BW), 10.1 ms (WOT)	12 ms (G to G BW), 9.4 ms (WOT)
	Surface Treatment	Hard coating (3H), Anti-glare treatment of the front polarizer (Haze 1% (Typ.))			
	Guaranteed Operating Hour	24 Hours			
	Orientation	Landscape & Portrait			
	Input	HDMI (2), DP, DVI-D, RGB, Audio			
	Output	DP, Audio, External Speaker			
PHYSICAL SPECIFICATION	External Control	RS232C in/out, RJ in, IR Receiver, Pixel Sensor, USB 3.0			
	Bezel Color	Black			
	Bezel Width	11.9mm(T/R/L), 18 mm(B)			
	Monitor Dimension (W x H x D)	1,456 x 838 x 41 mm	1,238x714.9x38.6 mm	1,102.2x638.5x38.6 mm	969.6x563.9x38.6 mm
	Weight (Head)	27.7 kg	17.3 kg	14.1 kg	9.8 kg
	Weight (Head + Stand)	32.9 kg	20.6 kg	17.4 kg	12.3 kg
SPECIAL FEATURES	Monitor with Optional Stand & Speaker Dimensions (W x H x D)	1,456.9 x 898.1 x 293.7 mm	1,238 x 773.4 x 219.6 mm	1,102.2 x 696.8 x 219.6 mm	969.6 x 622.2 x 193 mm
	Weight (Head + Stand + Speaker)	33.4 kg	21.1 kg	17.9 kg	12.8 kg
	Carton Dimensions (W x H x D)	561 x 977 x 190 mm	1,330 x 807 x 170 mm	1,197 x 760 x 166 mm	1,052 x 650 x 123 mm
	Packed Weight	33.6 kg	21.5 kg	17.2 kg	12.4 kg
	VESA™ Standard Mount Interface	300 x 300 mm	300 x 300 mm	300 x 300 mm	200 x 200 mm
		Temperature Sensor, Auto Brightness Sensor, Tile Mode(Up to 15x15), Energy Saving, Smart Energy Saving, File Play with USB, PIP/PBP (2), Internal Memory (8 GB), USB Cloning, Holiday Schedule, Wake on LAN, Mirroring, Embedded Template, Easy Brightness Control			
ENVIRONMENTAL CONDITIONS	Operating Temperature Range	0℃ to 40℃	0℃ to 40℃	0℃ to 40℃	0℃ to 40℃
	Operating Humidity Range	10% to 80%	10% to 80%	10% to 80%	10% to 80%
POWER CONSUMPTION	Power Supply	100-240 V~, 50/60 Hz			
	Power Type	Built-In Power			
	Power Switch	No			
STANDARD (CERTIFICATION)	Typ.	120 W	100 W	85 W	75 W
	Smart Energy Saving	85 W	70 W	60 W	55 W
MEDIA PLAYER COMPATIBILITY	Safety	UL / cUL / CB / TUV / KC			
	EMC	FCC Class "A" / CE / KCC			
SOFTWARE COMPATIBILITY	ErP / Energy Star	NA / Yes (Energy Star 7.0)			
	OPS Type Compatible	Yes			
SOFTWARE COMPATIBILITY	External Media Player Attachable	Yes (MP500 / MP700)	Yes (MP500 / MP700)	Yes (MP500 / MP700)	Yes (MP500 / MP700)
	Content Management Software	SuperSign Premium			
SOFTWARE COMPATIBILITY	Control and Monitoring Software	SuperSign Link			
	Basic	Remote Controller (included 2ea batteries), Power Cord, QSG, RGB Cable, Regulation Book, Phone to RS232C Gender, Memory cover			
SOFTWARE COMPATIBILITY	Speaker (SP-5000), Stand (ST-652T), Pixel Sensor (KT-SP0), xel Sensor (KT-SP0),	Speaker (SP-5000), Stand (ST-492T), Pixel Sensor (KT-SP0), Stand (ST-322T),	Speaker (SP-5000), Stand (ST-492T), Pixel Sensor (KT-SP0),	Speaker (SP-5000), Stand (ST-492T), Pixel Sensor (KT-SP0),	Speaker (SP-5000), Stand (ST-492T), Pixel Sensor (KT-SP0),

#전시용 #투명LCD패널 #터치패널적용가능 #박스/스탠드형으로커스터마이징가능 #핸드캐리가능



LCD

▪ Model	MP220A3CG
▪ Module Size	493.7x371mm
▪ Active Area	472x295mm
▪ Contrast Ratio	500:1
▪ Resolution	1680x1050
▪ Dimension	530x460x300mm
▪ Weight	15kg

#전시용 #투명LCD패널 #터치패널적용가능 #박스/스탠드형으로커스터마이징가능 #핸드캐리가능



LCD

▪ Model	MP460A3CG
▪ Module Size	1056.1x631.3mm
▪ Contrast Ratio	1300:1
▪ Resolution	1920x1050
▪ Dimension	1100x1900x625mm
▪ Weight	150kg



HARDWARE H 안드로이드전용

Android

Android Set Top Box

#Q-Sign최적화 #전원제어기능 #장시간콘텐츠재생가능



QA1800

▪ Model	QA1800
▪ OS	Android 7.1
▪ Chipset	RK3288
▪ CPU	ARM CORTEX-A17 1.6GHz
▪ GPU	ARM Mali-T764
▪ RAM	2GB
▪ Internal memory	16GB
▪ Video out	HDMI
▪ Interface	USB 2.0
▪ Wi-Fi	802.11b/g/n
▪ Ethernet	Ethernet (LAN) RJ45
▪ Keyboard/Mouse	support
▪ Dimension	139mm (W) * 123mm (D) * 43mm (H)

#안드로이드전용 #패드형 #색상변경가능 #전시장 #데모룸



LCD(7")

- Model 7inch Panel
- Resolution 1024*600
- Brightness 250cd/m²
- Contrast Ratio 500:1
- Aspect Ratio 16:9
- Disply area 1209.6(H)x680.4mm(V)
- Network 802.11b/g/n
100M/1000M Ethernet
Bluetooth 4.0
- Interface USB RJ45 HDMI
3.5mm earphone
- Power consumption 15W
- Speaker 2*1W
- Camera 2.0M/P,Front camera
- Dimension 181*10.5*120.6mm

설치사진



#안드로이드전용 #패드형 #색상변경가능 #전시장 #데모룸

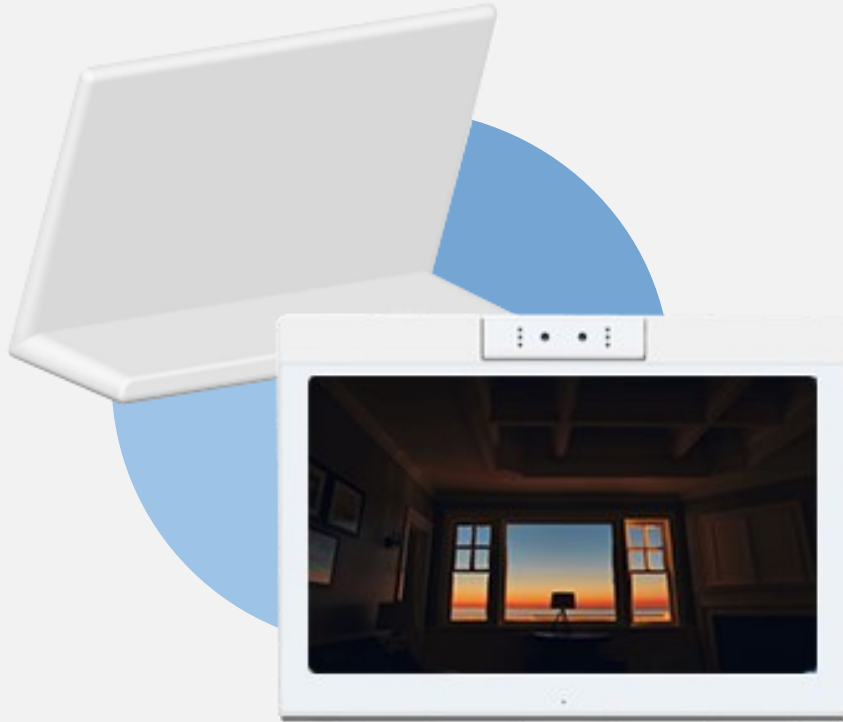

LCD(10")

▪ Model	10inch Panel
▪ Resolution	1280*800
▪ Brightness	250cd/m ²
▪ Contrast Ratio	800 : 1
▪ Aspect Ratio	16:9
▪ Network	802.11b/g/n 100M/1000M Ethernet Bluetooth 4.0
▪ Interface	USB RJ45 HDMI 3.5mm earphone
▪ Power consumption	15W
▪ Speaker	2*1W
▪ Camera	2.0M/P, Front camera
▪ Dimension	243*11.7*170mm
▪ Adapter	Adapter, 12V/1.5A

LCD(14")

▪ Model	14inch Panel
▪ Resolution	1920*1080
▪ Brightness	250cd/m ²
▪ Contrast Ratio	800 : 1
▪ Aspect Ratio	16:9
▪ Network	802.11b/g/n 100M/1000M Ethernet Bluetooth 4.0
▪ Interface	USB RJ45 HDMI 3.5mm earphone with microphone
▪ Power consumption	15W
▪ Speaker	2*2W
▪ Camera	2.0M/P, front camera
▪ Dimension	349*112*239mm(L*W*H)
▪ Adapter	Adapter, 12V/1.5A

#안드로이드전용 #패드형 #색상변경가능 #전시장 #데모룸



LCD

- Model 13inch Panel
- Resolution 1920*1080
- Brightness 250cd/m²
- Contrast Ratio 800 : 1
- Aspect Ratio 16:9
- Network 802.11b/g/n
100M/1000M Ethernet
Bluetooth 4.0
- Interface USB RJ45 HDMI
3.5mm earphone
- Power consumption 15W
- Speaker 2*2W
- Camera 2.0M/P, front camera
- Dimension 329*205*115mm(L*W*H)
- Adapter Adapter, 12V/1.5A

#안드로이드전용 #패드형 #색상변경가능 #전시장 #데모룸



LCD(15")

▪ Model	15inch Panel
▪ Resolution	1920*1080
▪ Brightness	250cd/m ²
▪ Contrast Ratio	800 : 1
▪ Aspect Ratio	16:9
▪ Network	802.11b/g/n 100M/1000M Ethernet Bluetooth 4.0
▪ Interface	USB RJ45 HDMI 3.5mm earphone with microphone
▪ Power consumption	15W
▪ Speaker	2*2W
▪ Camera	2.0M/P, front camera
▪ Dimension	389*242*142mm(L*W*H)
▪ Adapter	Adapter, 12V/1.5A

LCD(17")

▪ Model	17inch Panel
▪ Resolution	1920*1080
▪ Brightness	250cd/m ²
▪ Contrast Ratio	800 : 1
▪ Aspect Ratio	16:9
▪ Network	802.11b/g/n 100M/1000M Ethernet Bluetooth 4.0
▪ Interface	USB RJ45 HDMI 3.5mm earphone with microphone
▪ Power consumption	15W
▪ Speaker	2*2W
▪ Camera	2.0M/P, front camera
▪ Dimension	427*268*152mm(L*W*H)
▪ Adapter	Adapter, 12V/1.5A

#안드로이드전용 #패드형 #색상변경가능 #전시장 #데모룸



LCD

- Model 14inch Panel
- Resolution 1920*1080
- Brightness 250cd/m²
- Contrast Ratio 700 :1
- Aspect Ratio 16:9
- Network 802.11b/g/n
100M/1000M Ethernet
Bluetooth 4.0
- Interface USB RJ45 HDMI
3.5mm earphone
- Power consumption 15W
- Speaker 2*2W
- Camera 2.0M/P, front camera
- Dimension 342*220*25mm(L*W*H)
- Adapter Adapter, 12V/3A

#안드로이드전용 #패드형 #색상변경가능 #전시장 #데모룸



LCD(15")

▪ Model	15inch Panel
▪ Resolution	1920*1080
▪ Brightness	300cd/m ²
▪ Contrast Ratio	700 : 1
▪ Aspect Ratio	16:9
▪ Network	802.11b/g/n 100M/1000M Ethernet Bluetooth 4.0
▪ Interface	USB RJ45 HDMI 3.5mm earphone
▪ Power consumption	15W
▪ Speaker	2*2W
▪ Camera	2.0M/P, front camera
▪ Dimension	388*245*27mm(L*W*H)
▪ Adapter	Adapter, 12V/3A

LCD(17")

▪ Model	17inch Panel
▪ Resolution	1920*1080
▪ Brightness	250cd/m ²
▪ Contrast Ratio	700 : 1
▪ Aspect Ratio	16:9
▪ Network	802.11b/g/n 100M/1000M Ethernet Bluetooth 4.0
▪ Interface	USB RJ45 HDMI 3.5mm earphone
▪ Power consumption	15W
▪ Speaker	2*2W
▪ Camera	2.0M/P, front camera
▪ Dimension	417*262*27mm(L*W*H)
▪ Adapter	Adapter, 12V/3A

#안드로이드전용 #패드형 #색상변경가능 #전시장 #데모룸



LCD(18")

▪ Model	18inch Panel
▪ Resolution	1920*1080
▪ Brightness	250cd/m ²
▪ Contrast Ratio	700 : 1
▪ Aspect Ratio	16:9
▪ Network	802.11b/g/n 100M/1000M Ethernet Bluetooth 4.0
▪ Interface	USB RJ45 HDMI 3.5mm earphone
▪ Power consumption	15W
▪ Speaker	2*2W
▪ Camera	2.0M/P, front camera
▪ Dimension	468*288*38mm(L*W*H)
▪ Adapter	Adapter, 12V/3A

LCD(17")

▪ Model	21inch Panel
▪ Resolution	1920*1080
▪ Brightness	250cd/m ²
▪ Contrast Ratio	700 : 1
▪ Aspect Ratio	16:9
▪ Network	802.11b/g/n 100M/1000M Ethernet Bluetooth 4.0
▪ Interface	USB RJ45 HDMI 3.5mm earphone
▪ Power consumption	15W
▪ Speaker	2*3W
▪ Camera	2.0M/P, front camera
▪ Dimension	538*331*37mm(L*W*H)
▪ Adapter	Adapter, 12V/3A

#안드로이드전용 #패드형 #색상변경가능 #전시장 #데모룸



LCD

- Model 32inch Panel
- Resolution 1920*1080
- Brightness 250cd/m²
- Contrast Ratio 3000 :1
- Aspect Ratio 16:9
- Network 802.11b/g/n
100M/1000M Ethernet
Bluetooth 4.0
- Interface USB RJ45 HDMI
3.5mm earphone
- Power consumption 35W
- Speaker 2*3W
- Dimension 750*449*42mm(L*W*H)
- Adapter Adapter, 12V/5A

#안드로이드전용 #패드형 #색상변경가능 #미러키오스크 #벽걸이



LCD

- Size 3.6inch
- Brightness 300cd/m²
- Aspect Ratio 16:9
- Resolution 1920x1080(FHD)

KIOSK

- Dimension 800x600x23mm
- Weight 12.5 kg
- Material Metal, Safety tempered glass
- Operating temperature 0~35°C
- Input 100~240V
- Power consumption 25W

설치사진



H10

QMT10A01

#안드로이드전용 #패드형 #색상변경가능 #미러키오스크 #거울형

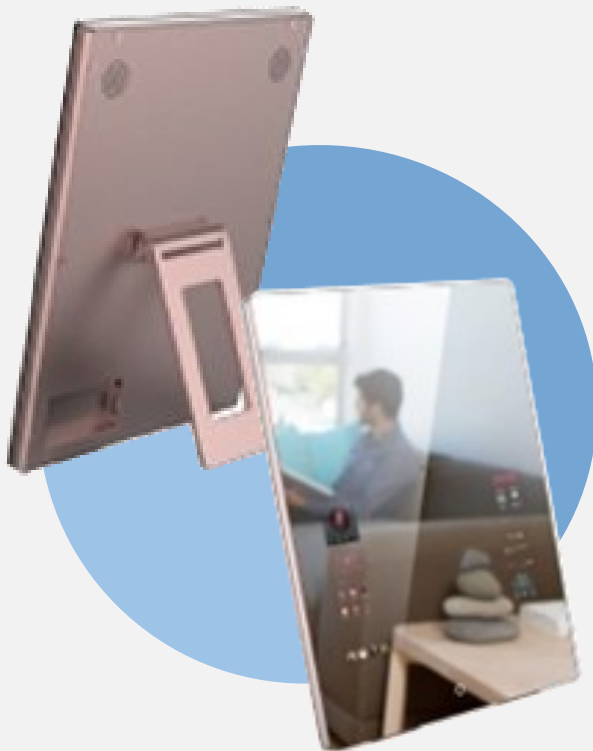

LCD

- Size 10.1 inch
- Brightness 150 cd/m²
- Resolution 1200x1920(FHD)

KIOSK

- Dimension 360x270x15.7mm
- Weight 2.2 kg
- Material Metal
- Operating temperature 0~40°C
- Input 100-240V
- Power consumption 25W

#안드로이드전용 #패드형 #색상변경가능 #벽걸이



LCD

▪ Model	BOE
▪ Active Area	293.76*165.24mm
▪ Brightness	400cd/m ²
▪ Contrast Ratio	800:1
▪ Aspect Ratio	16:9
▪ Resolution	1920*1080

KIOSK

▪ Dimension	381*240*100mm ± 200mm
▪ Weight	5kg
▪ Material	SPCC 냉간압연강판
▪ Operating temperature	-10~40℃
▪ Input	12V-24V
▪ Power consumption	45W

설치사진



HARDWARE | LED
LED

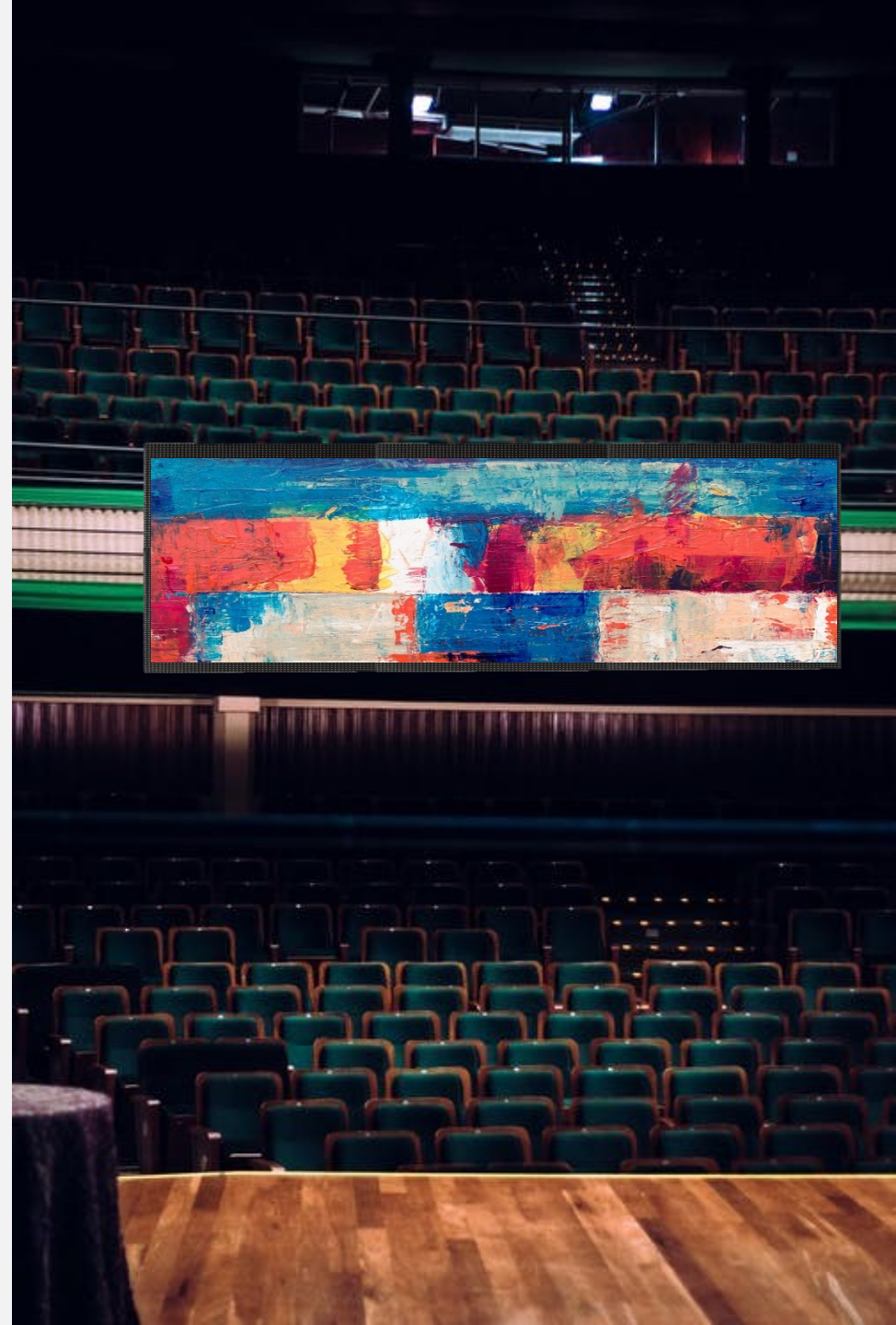

#LED #전광판 #P3LED #대형LED

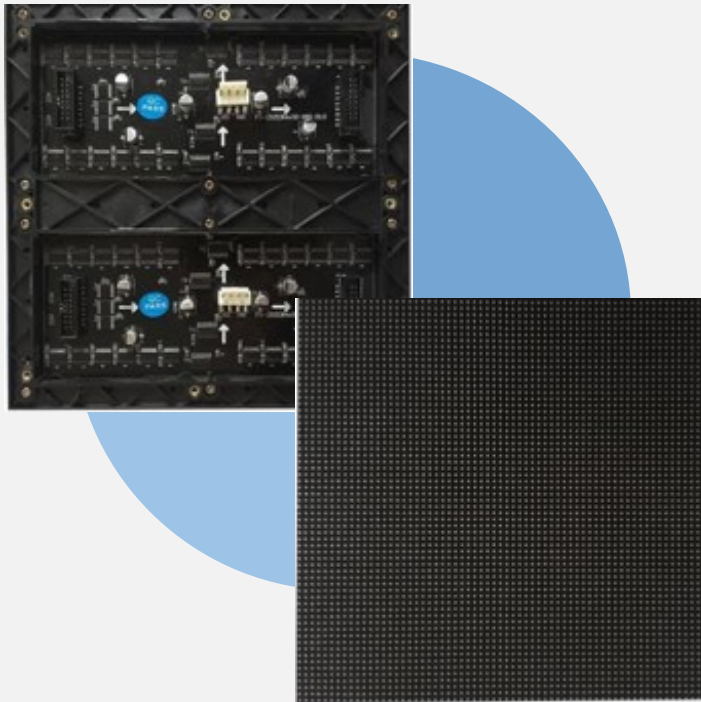

P3LED

Physical Pitch	3mm
Pixel Configuration	SMD 2121
Pixel Density	111111dots/m ²
LED Module Dimensions (mm)	192 *192
Panel Dimensions (WxHxD) (mm)	6528 X 576 X 10
Physical Resolution of Module (WxH)	64*64
No.of Modules Per Panel (WxH)	
Weight Per Panel	0.3kg/panel
Weight Per m ²	25kg/m ²
Processing	16bit
Colours	429 Trillions
Contrast Ratio	≥5000: 1
Average Power Consumption	350~800W/panel
Max Power Consumption	3000W/panel
Operating Temp/Humidity	-25 ~ +65 °C / 10% ~ 95%RH
Storage Temp/Humidity	-40 ~ +85 °C / 10% ~ 95%RH
Brightness	1000CD/m ²
Refresh Rate	3840Hz can be set (refresh rate is higher, it looks soft and comfortable to the naked eye, and it does not hurt the eyes when playing PPT pictures)
Horizontal Viewing Angle	≥160°
Vertical Viewing Angle	≥160°
Expected LED Lifetime (Max)	≥ 100,000 hours
Max Stacking	102 panels

설치사진

6580* 630* 100mm

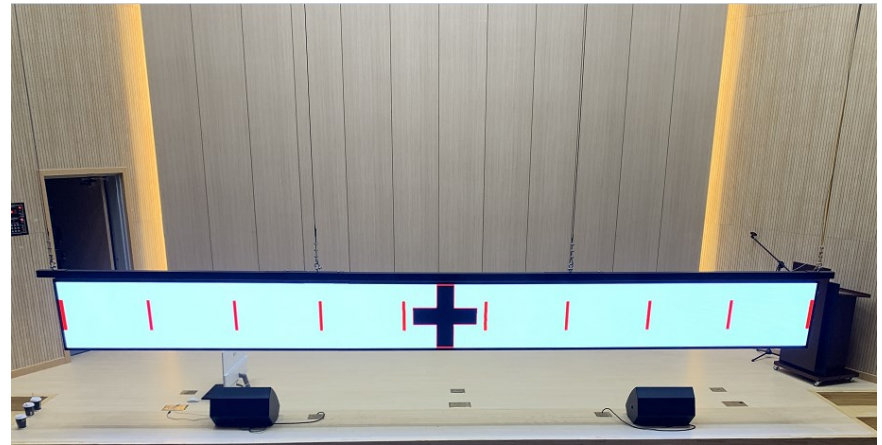
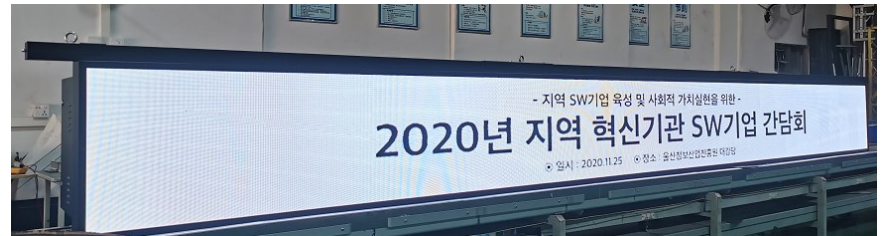
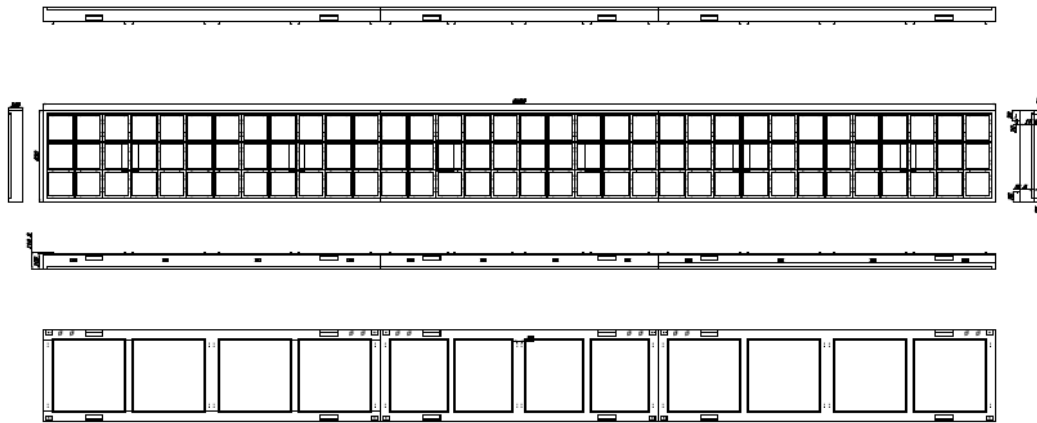

#전남관광재단 무안 공항 #양면LED #천정형

설치사진

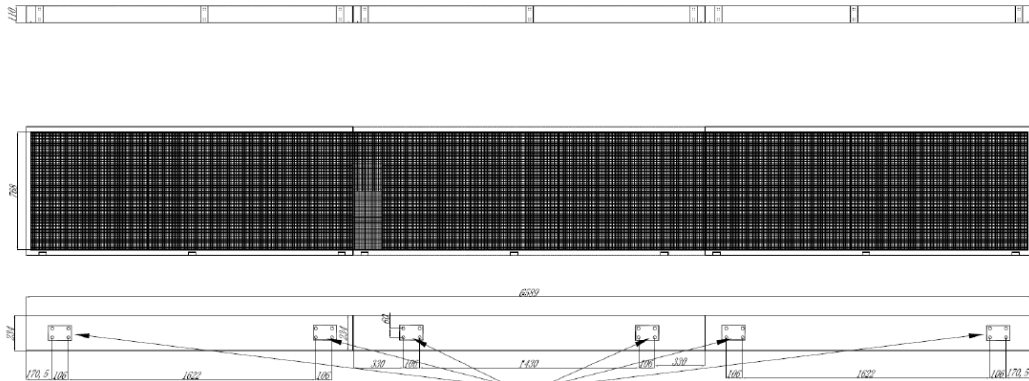

전산볼트 조립 위치
총 24개

소비전력 9~10KW
전체 무게 300KG

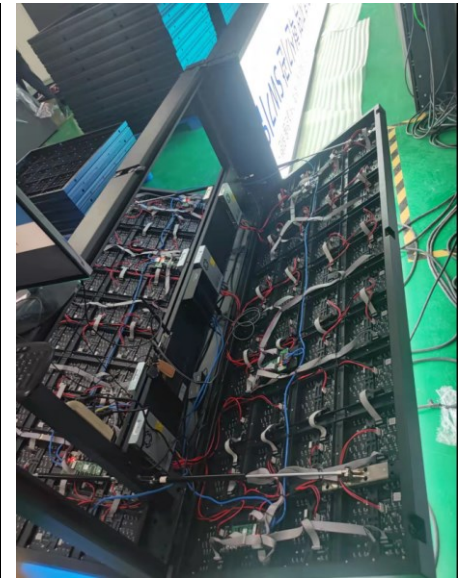
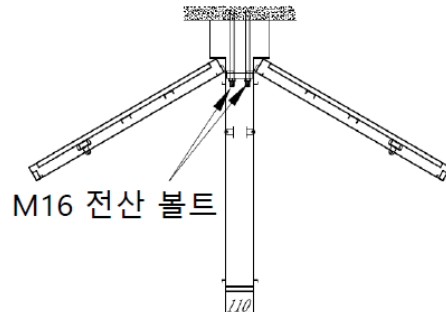
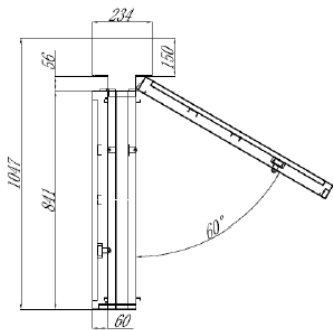



HARDWARE J

Video Wall



#비디오월 #55인치 2*4 #정면 유지보수

2*4 비디오월 설치 사진



도면

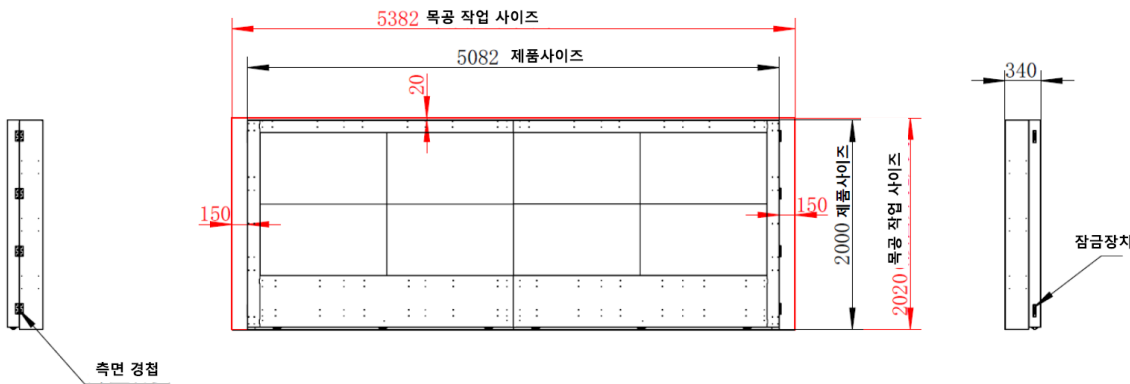

2*4 비디오월

- Model 55inch Panel
- Resolution 1920*1080
- Brightness 500cd/m²
- Contrast Ratio 800 : 1
- Aspect Ratio 16:9
- Network 100M/1000M Ethernet
- Interface USB RJ45 HDMI
- Power consumption 1200W
- Dimension 5082*340*2000mm(L*W*H)
- Adapter Adapter, 12V/1.5A
- Other Video wall control box

#비디오월 #55인치 1*4

2*4 비디오월 설치 사진



도면

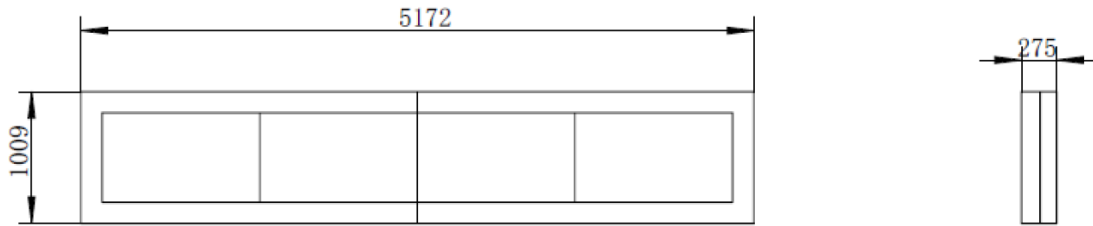

1*4 비디오월

- Model 55inch Panel
- Resolution 1920*1080
- Brightness 500cd/m²
- Contrast Ratio 800 :1
- Aspect Ratio 16:9
- Network 100M/1000M Ethernet
- Interface USB RJ45 HDMI
- Power consumption 1200W
- Dimension 5172*275*1009mm(L*W*H)
- Adapter Adapter, 12V/1.5A
- Other Video wall control box

#비디오월 #전면탈부착수리가능 \$49인치

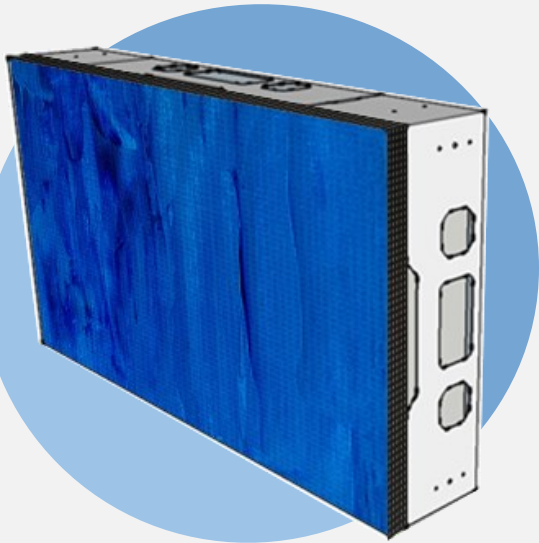

Connectivity&Control

- Input Connection AV, Component, PC Analog, DVI
- Input Audio PC, DVI, AV, Component Audio
- Output Connection DVI, PC Analog, AV, Component
Speaker Out 2Channel Speaker(8Ω)
Comport (RS232C) 1/9 Pin Male T

LCD(QVW55A03)

- Resolution 1920x1080
- Brightness 500cd m²
- Contrast Ratio 1400:1
- Bezel(One Side) R/B:1.25mm, U/L:2.25mm
- Viewing Angle 178° / 178° (Horizontal / Vertical)
- Lifetime 60,000Hours
- Power Consumption 220W
- Dimension 1,214.5 x 685.3 x 213.6 mm
- Weight 45kg
- Option Tempered glass, Camera, Touch

LCD (QVW55A04)

- Resolution 1920x1080
- Brightness 700cd m²
- Contrast Ratio 1400:1
- Bezel(One Side) R/B:1.25mm, U/L:2.25mm
- Viewing Angle 178° / 178° (Horizontal / Vertical)
- Lifetime 60,000Hours
- Power Consumption 220W
- Dimension 1,214.5 x 685.3 x 213.6 mm
- Weight 45kg
- Option Tempered glass, Camera, Touch

LCD (QVW55A05)

- Resolution 1920x1080
- Brightness 500cd m²
- Contrast Ratio 1400:1
- Bezel(One Side) R/B:0.9mm, U/L:0.9mm
- Viewing Angle 178° / 178° (Horizontal / Vertical)
- Lifetime 60,000Hours
- Power Consumption 220W
- Dimension 1,212.8 x 683.6 x 213.6 mm
- Weight 43kg
- Option Tempered glass, Camera, Touch

#비디오월 #전면탈부착수리가능 \$49인치

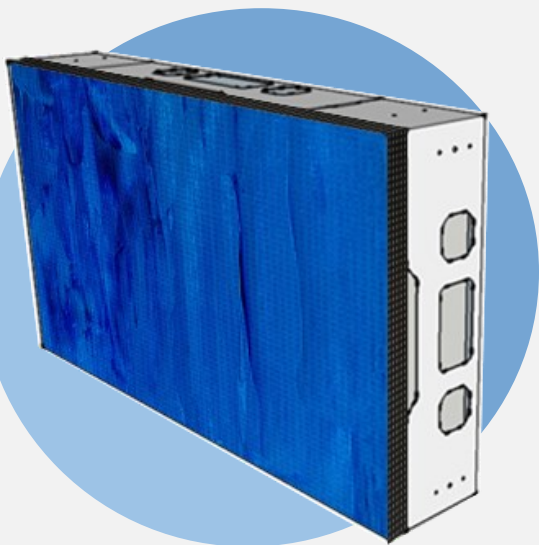

LCD (QVW55A06)

- Resolution 1920x1080
- Brightness 700cd m²
- Contrast Ratio 1400:1
- Bezel(One Side) R/B:0.9mm, U/L:0.9mm
- Viewing Angle 178° / 178° (Horizontal / Vertical)
- Lifetime 60,000Hours
- Power Consumption 220W
- Dimension 1,212.8 x 683.6 x 213.6 mm
- Weight 43kg
- Option Tempered glass, Camera, Touch

LCD (QVW55A07)

- Resolution 1920x1080
- Brightness 700cd m²
- Contrast Ratio 3500:1
- Bezel(One Side) R/B:0.9mm, U/L:0.9mm
- Viewing Angle 178° / 178° (Horizontal / Vertical)
- Lifetime 50,000Hours
- Power Consumption 220W
- Dimension 1,212.8 x 683.6 x 213.6 mm
- Weight 43kg
- Option Tempered glass, Camera, Touch

HARDWARE K
ROBOT



#음성인식 #길안내 #얼굴인식 #음성안내 #장애물 회피



상세 스펙

SORT	STANDARD	PREMIUM
SIZE	L590*W590*H1590	
WEIGHT	60KG	
MATERIAL	ABS 부품, 섬유 강화 플라스틱 하우징	
RATED POWER	80W	
AMBIENT LIGHT	팔 부분 *2	
SPEAKER	15W HiFi 내장 스피커	
MIC	AIUI 마이크: 인식 거리 : 최대 5M, 각도 : 0-180°, 소음 감소 특성	
CAMERA	얼굴인식 카메라 수직 및 수평 시야각 : 125°, 역광 방지, 해상도 300 million pixels	
	-	3D 모션 감지 카메라
SCREEN	23.6인치 PCAP 터치 스크린 1920*1080P 로봇 눈 부분 LCD스크린 320*240	
MOVING	로봇 머리 부분: 수평 회전 각도 : ± 40°, 수직 회전 각도 : ± 10° 경사에 적응 : ± 3° (참고 : 경사에 머물 수 없음) 최대 속도 : ≤1m / s	
PERIPHERALS	-	58mm 프린트기
	-	NFC
	-	QR스캐너
BATTERY	24V 30Ah, 이동 시간: 10H, 충전 시간: 4H	

SORT	STANDARD	PREMIUM
SENSOR	초음파 센서*2: 스캔 거리 : 1900mm, 상하 좌우 스캔 각도 : ± 30° 인체감지센서*2: 스캔 거리 : 5M, 스캔 각도 : ± 45°	
CHARGE	전압 : 200-240VAC, 충전 전류 : 6A	
SYSTEM	Android5.1	
CPU	RK3368	
INTERNET	WIFI 2.4G/5G	
RAM	DDR4_2400 4G	
SSD	128G	
NAVIGATION	시야 : 360° 측정 사각 지대 : 0.1m 측정 해상도 : 3cm 통신 속도 : 256000bps 작동 거리 : 흰색 물체 : 40 M 검정 색 물체 : 10 M 측정 정확도 : ± 5cm * 작동 전압 : 전형 5V 전력 소비 : 3W 작동 온도 : 25 °C	시야 : 270° 작동 거리 : 0.05 ~ 10M 응답 시간 : 67ms 시스템 오류 : ± 60mm 통계 오류 : ± 20 mm 작동 전압 : 0 V DC-28 V DC 전력 소비 : 3W 등급 : IP 65
AVOIDANCE SYSTEM	Lidar : 스캔 거리 : 0.05 ~ 8M, 스캔 각도 : 270° 초음파 센서*2: 스캔 거리 : 1900mm, 상하 좌우 스캔 각도 : ± 30°	
DEVELOPMENT	API, SDK	

#음성인식 #길안내 #얼굴인식 #음성안내 #장애물 회피



Specifcaiton

▪ Size	L540*W470*H1400
▪ Speed	0~0.7m/s
▪ Endurance Time	≥ 10h
▪ Charging Time	≤ 10h
▪ Screen Size	23.8 inch
▪ Battery Capacity	40Ah
▪ Control System	Android
▪ Camera	Face Recognition
▪ Navigation Mode	Laser Navigation
▪ Power	120W

#음성인식 #길안내 #얼굴인식 #음성안내 #장애물 회피



Specificaiton

▪ Size	L544*W530*H1358
▪ Net Weight	31kg
▪ Endurance Time	≥ 10h
▪ Charging Time	≤ 10h
▪ Screen Size	23.8 inch
▪ Battery Capacity	40Ah
▪ Control System	Android
▪ Camera	Face Recognition
▪ Navigation Mode	Laser Navigation
▪ Power	120W

#음성인식 #길안내 #얼굴인식 #음성안내 #장애물 회피



Specifaciton

- | | |
|--------------------|------------------|
| ▪ Size | L560*H1465 |
| ▪ Net Weight | 85kg |
| ▪ Endurance Time | ≥ 8-9h |
| ▪ Charging Time | ≤ 6h |
| ▪ Screen Size | 21.5 + 12.5 inch |
| ▪ Battery Capacity | 40Ah |
| ▪ Control System | Android |
| ▪ Camera | Face Recognition |
| ▪ Navigation Mode | Laser Navigation |
| ▪ Power | 120W |

#음성인식 #길안내 #얼굴인식 #음성안내 #장애물 회피

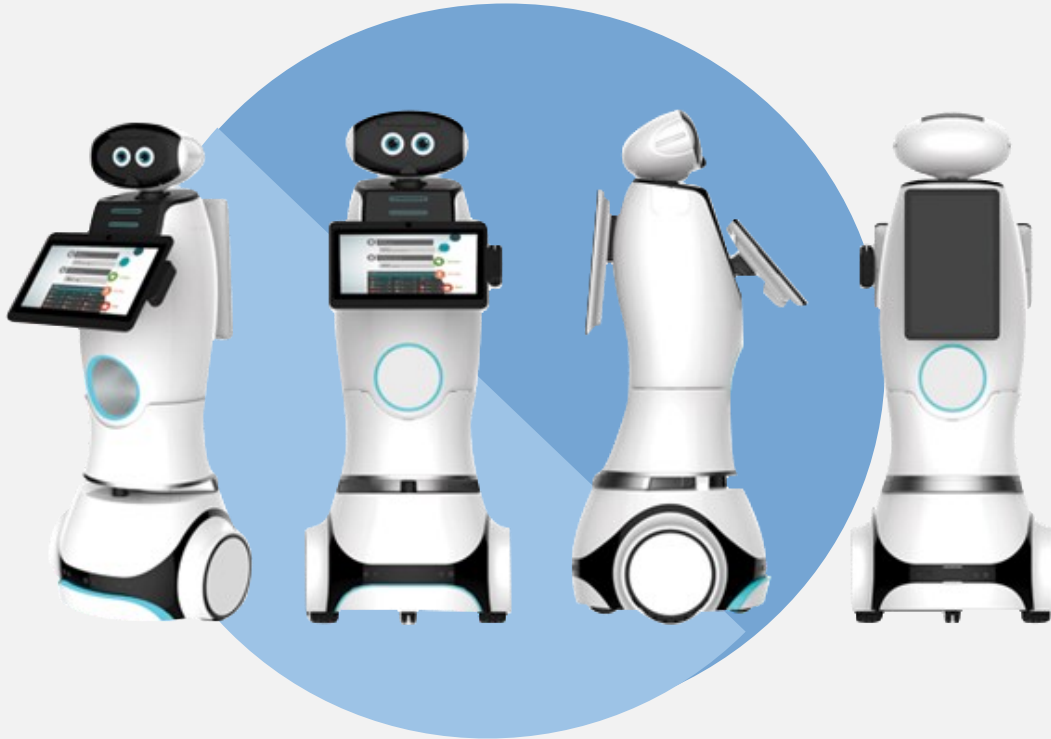

Specificaition

- | | |
|--------------------|------------------|
| ▪ Size | L544*W530*H1358 |
| ▪ Net Weight | 50kg |
| ▪ Endurance Time | ≥ 8-9h |
| ▪ Charging Time | ≤ 6h |
| ▪ Screen Size | 21.5 + 12.5 inch |
| ▪ Battery Capacity | 40Ah |
| ▪ Control System | Android |
| ▪ Camera | Face Recognition |
| ▪ Navigation Mode | Laser Navigation |
| ▪ Power | 120W |

#음성인식 #길안내 #얼굴인식 #음성안내 #장애물 회피



Specificaion

▪ Size	L544*W530*H1358
▪ Net Weight	50kg
▪ Endurance Time	≥ 8-9h
▪ Charging Time	≤ 6h
▪ Screen Size	21.5 inch
▪ Battery Capacity	40Ah
▪ Control System	Android
▪ Camera	Face Recognition
▪ Navigation Mode	Laser Navigation
▪ Power	120W

#음성인식 #길안내 #얼굴인식 #음성안내 #장애물 회피



Specificaiton

▪ Size	L544*W530*H1358
▪ Net Weight	50kg
▪ Endurance Time	≥ 8-9h
▪ Charging Time	≤ 6h
▪ Screen Size	21.5 + 12.5 inch
▪ Battery Capacity	40Ah
▪ Control System	Android
▪ Camera	Face Recognition
▪ Navigation Mode	Laser Navigation
▪ Power	120W

#음성인식 #길안내 #얼굴인식 #음성안내 #장애물 회피



Specificaiton

- | | |
|--------------------|------------------|
| ▪ Size | L680*W570*H1500 |
| ▪ Net Weight | 65kg |
| ▪ Endurance Time | ≥ 8-9h |
| ▪ Charging Time | ≤ 4~5h |
| ▪ Screen Size | 10.1+21.5 inch |
| ▪ Battery Capacity | 20Ah |
| ▪ Control System | Android |
| ▪ Camera | Face Recognition |
| ▪ Navigation Mode | Laser Navigation |
| ▪ Power | 80W |



THANK YOU

For more information, visit
<http://www.netds.net>